

X Family Displays

Horizon Operator's Manual



X Family Displays

Horizon Operator Manual

Part Number: 1046492-01

Revision B

For use with Software Version 5.02

© Copyright Topcon Precision Agriculture

January 2022

All contents in this manual are copyrighted by Topcon. All rights reserved. The information contained herein may not be used, accessed, copied, stored, displayed, sold, modified, published or distributed, or otherwise reproduced without express written consent from Topcon.

This manual provides information about operating and maintaining this Topcon Precision Agriculture product. Correct use and servicing is important for safe and reliable operation of the product.

It is very important that you take the time to read this manual before using the product.

Information in this manual is current at the time of publication. A system may vary slightly. The manufacturer reserves the right to redesign and change the system as necessary without notification.

Technical documentation and utility software

On the myTopcon NOW! support website (mytopconnow.topconpositioning.com) or myTopcon NOW! app you can access the following support material:

- Firmware and software updates
- Product manuals
- Product quick guides
- Training videos
- System layouts

Register for a free account today to access this material.



Table of contents

Chapter 1 – Display Overview	1
1.1. Introduction	1
1.1.1. What's new in 5.02	1
1.2. Using Topcon Agriculture Platform (TAP)	3
1.2.1. Logging in to TAP on the display	3
1.2.2. Viewing optional features via Marketplace	4
1.3. Icon descriptions	6
1.3.1. Guidance toolbar	6
1.3.2. Menu icons	6
1.3.3. Navigation bar icons	9
1.3.4. View controls	10
1.3.5. Other icons	11
1.4. Starting the display	12
1.4.1. Display power LED (X35 only)	13
1.5. Shutting down or restarting the display	14
1.6. Using the display toolbar	15
Chapter 2 – User Interface Description	17
2.1. Switch between setup and operation screen	17
2.2. Setup screen controls	18
2.3. Operation screen controls	20
2.3.1. Implement color indicators	21
Chapter 3 – Quick Setup Guide	22
3.1. Firmware / software update instructions	22
3.2. Getting started	24
Chapter 4 – Regional and User Settings	26
4.1. Setting the region	27
4.1.1. Language setup	27
4.1.2. Time/date setup	27
4.1.3. Units setup	28
4.2. Setting up the lightbar	31
4.3. Setting up environment	33
4.4. Setting up map options	35
4.5. Setting access level	37

4.6. Setting user controls	38
4.7. Setting up remote support	40
4.7.1. Setting up support	40
4.7.2. Requesting support	41
Chapter 5 – System Setup	43
5.1. Setting system settings	44
5.2. Setting features	46
5.2.1. Licenses setup	46
5.2.2. Console setup	47
5.2.3. Guidance setup	50
5.2.4. Implement setup	51
5.2.5. XTEND setup	53
5.2.6. VDC setup	57
5.3. Setting up GPS	59
5.3.1. Receiver setup	59
5.3.2. Correction setup	61
5.3.3. Output setup (X25/X35 only)	67
5.3.4. Radar setup (X25/X35 only)	68
5.4. Setting up serial ports (X25/X35 only)	69
5.5. Setting up alarms	70
5.5.1. Alarm window description	72
5.5.2. Alarms list	72
5.6. Setting up flag points	81
5.7. Setting up ISOBUS / universal terminal	82
5.7.1. File server setup	82
5.7.2. Task controller setup	83
5.7.3. Universal terminal setup	83
5.7.4. Auxiliary control setup	85
5.8. Setting up utilities	89
5.8.1. Display software upgrade (X25/X35)	89
5.8.2. Display software upgrade (XD/XD+)	89
5.9. Setting up Wi-Fi	90
5.9.1. Ethernet radio modem (CL-55)	90
5.9.2. USB Wi-Fi	90

Chapter 6 – Vehicle Setup	94
6.1. Selecting a vehicle	95
6.2. Creating a new vehicle	96
6.2.1. Customizing a vehicle	97
6.3. Setting the vehicle geometry	99
6.4. Setting up the steering controller	101
6.5. Selecting the vehicle antenna	103
6.6. Setting up GPS speed emulation	104
Chapter 7 – Implement Setup	105
7.1. Selecting an implement	110
7.2. Setting up a new implement	112
7.3. Setting the implement geometry	115
7.4. Setting up section control	117
7.4.1. Setting timing	118
7.4.2. Setting up the section switch	119
7.5. Setting up the master switch	121
Chapter 8 – Product Setup	123
8.1. Setting up the product database	123
Chapter 9 – Operation Basics	125
9.1. Using mini-views	125
9.2. Viewing system information	127
9.3. Viewing guidance	128
9.3.1. Guidance color scheme	128
9.3.2. Using view controls	129
9.3.3. Select mode	130
9.3.4. Map layers	130
9.4. Viewing GPS details	135
9.5. Viewing diagnostics	138
9.6. Viewing task information	140
9.7. Monitoring on the dashboard	142
9.7.1. Customizing the dashboard	142
9.8. Recognizing color and working status	145
9.9. Understanding default file names	146

Chapter 10 – Steering Calibrations	147
10.1. Calibrating the compass	148
10.2. Calibrating the wheel angle sensor	149
10.3. Calibrating the mounting bias	151
10.4. Dealing with calibration errors/alarms	156
Chapter 11 – Task Button	158
Chapter 12 – Field Menu	161
12.1. Selecting a field	161
12.2. Creating a field	163
12.3. Unloading a field	164
12.4. Setting flag points	165
12.4.1. Working with flag points	166
12.5. Setting a new boundary	168
12.5.1. Creating a boundary from coverage	170
12.5.2. Creating a boundary from a shapefile	171
12.5.3. Editing a boundary	172
12.5.4. Removing a boundary	173
12.6. Setting up a working headland	174
Chapter 13 – Task Menu	178
13.1. Selecting an existing task	178
13.2. Creating a new task	179
13.3. Configuring task regions	180
13.4. Clearing a task	182
13.5. Configuring variable rate control	183
13.5.1. Source options	184
Chapter 14 – Guideline Menu	187
14.1. Selecting an existing guideline	189
14.2. Using straight lines guidelines	190
14.2.1. Setting AB lines manually	191
14.3. Using identical curve guidelines	193
14.4. Using center pivot guidelines	194
14.5. Using guidelock guidance mode	195
14.6. Using boundary steering	196

14.7. Using project lines	198
14.7.1. Generating as-driven lines	198
14.7.2. Splitting existing project lines	199
14.7.3. Add offset lines for existing project lines	200
14.8. Setting up tramlines	203
14.9. Configure headland turns	206
14.9.1. Turn radius	207
14.9.2. Turn line location	209
14.9.3. Pattern	210
14.9.4. Select pattern	210
14.9.5. Headland turn alarm	212
Chapter 15 – Guideline Groups	214
15.1. Selecting an existing guideline group	216
15.2. Importing existing guidelines	217
15.2.1. Import guidelines from USB	217
15.2.2. Import guidelines from TAP	218
15.2.3. Copy guidelines	218
Chapter 16 – Auto Steering	219
16.1. Auto steer status	219
16.1.1. Auto steer troubleshooting	220
16.2. Tuning auto steer	224
16.3. Engaging auto steer	226
16.4. Disengaging auto steer	228
Chapter 17 – Nudge Menu	229
17.1. Using nudge options	229
17.2. Compensating for GPS drift	231
17.2.1. Compensating correctly for GPS drift	232
17.2.2. High accuracy correction sources	233
Chapter 18 – Enabled Additional Features	234
18.1. Using auto section control	234
18.1.1. Boom control	235
18.2. Using universal terminal (ISOBUS)	237
18.3. Using weather station	239

18.3.1. Calibrating weather station	239
18.4. Using NORAC Boom Height Control	241
18.5. Using plot planter	243
18.5.1. Creating a plot planter implement	243
18.5.2. Plot planter user interface	244
Chapter 19 – Inventory Manager	248
19.1. Exporting tasks / task data / task reports	252
19.1.1. Exporting tasks to a USB	252
19.1.2. Exporting task reports to a USB	254
19.1.3. Exporting a task data set to a USB	254
19.1.4. Exporting a task data set to TAP	256
19.2. Importing tasks and task data	257
19.2.1. Importing tasks from a USB	257
19.2.2. Importing a task data selection from a USB	257
19.2.3. Importing legacy Horizon 3 or 4 data from a USB	257
19.2.4. Importing a task data set from a USB	258
19.2.5. Importing a task data selection from TAP	258
Chapter 20 – Troubleshooting Guide	260
20.1. Common error messages	260
20.2. Internet connection issues	265
Chapter 21 – Glossary	266
Chapter 22 – Index	271
Chapter 23 – Regulatory and Safety Warnings	274
23.1. Topcon Positioning Systems, Inc. End User License Agreement ..	283

Chapter 1 – Display Overview

1.1. Introduction

The display is a vehicle-mounted electronic display with LCD display and touchscreen. It allows operators to work with auto steering, guidance and other control functions from the display. The display is designed to interact with GPS and Electronic Control Units (ECUs), centralizing the ability to communicate, record, store and display data for agricultural uses.

Note: Before using guidance and auto steering, please read the safety instructions and learn about the controls by reading this manual carefully. Contact your dealer if assistance is required with setting up or operating the display.

The display is a touchscreen. To select something on the screen, touch the area with the tip of a finger.

The display serial number is located on a sticker on the rear of the display. Record the serial number for future reference.

Serial Number:

1.1.1. What's new in 5.02

- A free trial license is available for Horizon features (see [Licenses setup, page 46](#)).
- Multiple implements can be used at the same time (see [Implement Setup, page 105](#)).
- ISOBUS implement profiles are generated automatically (see [Implement Setup, page 105](#)).
- The use of guideline groups is optional (see [Guideline Groups, page 214](#)).
- Screen capture video is available (see [Using the display toolbar, page 15](#)).

1.1. Introduction

- There is a restart option for the display (see [Shutting down or restarting the display, page 14](#)).
- Plot planter functionality has been added (see [Using plot planter, page 243](#)).
- Custom flag point perimeters and warnings (see [Setting flag points, page 165](#)).
- There is a new 'wayline selection aggressiveness' option when tuning steering (see [Tuning auto steer, page 224](#)).

1.2. Using Topcon Agriculture Platform (TAP)

TAP is Topcon's IoT platform that provides connectivity and allows the user to import/export agricultural operational data, share data, create prescriptions, monitor fleet telematics, and conduct remote support. TAP is seamlessly integrated with Horizon software to provide wireless data transfer and telematics to a TAP equipped X Display.

From the display you can export and import task data sets via TAP. See [Exporting tasks / task data / task reports, page 252](#) and [Importing tasks and task data, page 257](#).

When logged into the TAP account for first time, your existing display data is automatically uploaded to your TAP account.

When a task is stopped it is automatically uploaded to your TAP account.



Purchased optional features may also be displayed via Marketplace. See [Viewing optional features via Marketplace, page 4](#).

The TAP website is tap.topconagriculture.com.

Note: Contact your dealer to set up a login for TAP.

1.2.1. Logging in to TAP on the display

Note: A wireless internet connection is required. See [Setting up Wi-Fi, page 90](#).

- To enable TAP on the display, select **System**  / **Features**  / **Console**  / **Cloud Based Services** and select **TAP - Topcon Agriculture Platform**.
- Select the TAP button on the left of the operation screen or go to the System setup page to login to TAP.

1.2. Using Topcon Agriculture Platform (TAP)

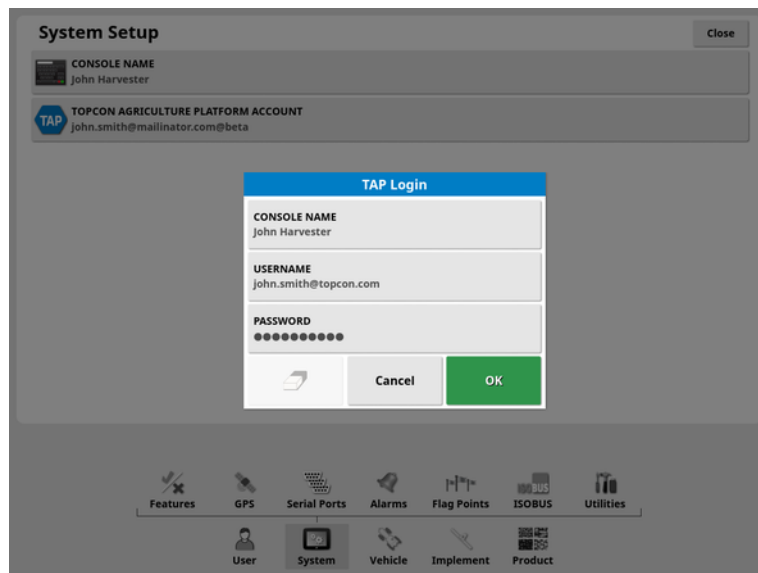
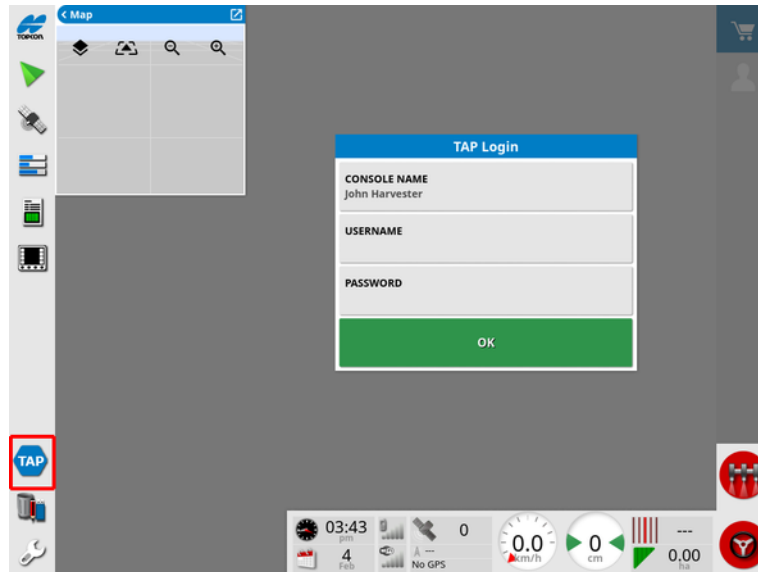

Once the display is logged into TAP, it will establish communication whenever a TAP operation is required and internet is available.

1.2.2. Viewing optional features via Marketplace

The display is supplied with a range of features that are provided as standard. There are also optional features that can be accessed via subscription.

Once you are logged into TAP, Horizon Marketplace is accessible by selecting the TAP button on the left of the screen.

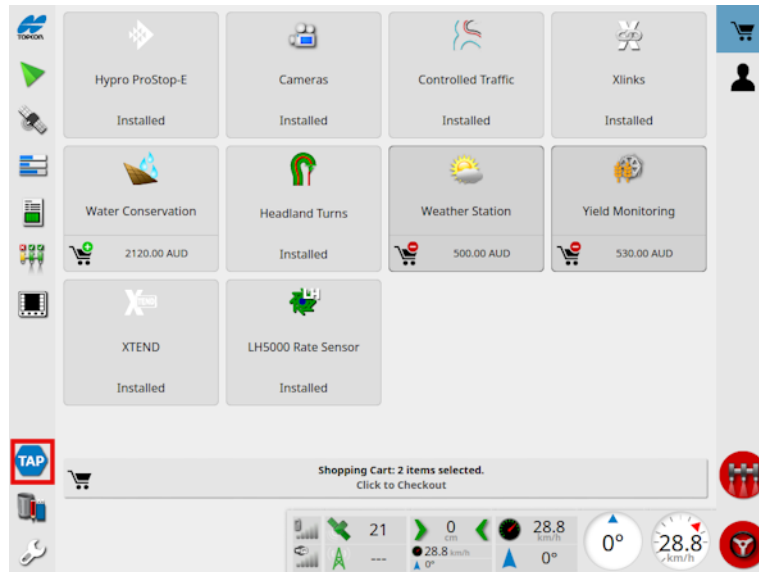

This displays optional features available for subscription from your dealer via TAP. Features already licensed are shown as installed.

See [Licenses setup, page 46](#).

To hide Marketplace, select the TAP button on the left menu.

1.3. Icon descriptions

1.3.1. Guidance toolbar



Task button, [158](#)



Field menu, [161](#)



Task menu, [178](#)



Guideline menu, [187](#)



Guideline group menu, [214](#)



Steering options menu, [219](#)



Auto steer calibration (if Auto Steer is disabled, XD only), [147](#)



Nudge menu, [229](#)

1.3.2. Menu icons

Field menu



Field menu, [161](#)



Select field, [161](#)



New field, [163](#)



Unload field, [164](#)



Set flag point, [165](#)



Record field boundary, [168](#)



Complete field boundary recording, [168](#)



Boundary recording offset, [168](#)



Configure headland, [174](#)



Clear field boundary, [173](#)



Create boundary from shapefile, [171](#)



Create boundary from coverage, [170](#)

Task menu



Task menu, [178](#)



Select task, [178](#)



Join task (using MachineLink), [51](#)



Create new task, [179](#)



Configure task regions, [180](#)



Clear task data, [182](#)



Configure VRC, [183](#)

Guideline menu



Guideline menu, [187](#)

1.3. Icon descriptions



Select guideline, [189](#)



Cycle guidance mode, [187](#)



Cycle guideline, [189](#)



Create guideline, [190](#)



Record AB line, [190](#)



Record identical curve, [193](#)



Record pivot, [194](#)



Open manual AB line entry window, [191](#)



New project lines, [198](#)



Configure tramlines, [203](#)



Configure headland turns, [206](#)

Guideline group menu



Select guideline group, [216](#)



Create new guideline group, [214](#)



Import existing guideline, [217](#)

Steering options menu



Steering options menu, [219](#)



Auto steer status, [219](#)

 Auto steer tuning parameters, [224](#)

 Auto steer calibration, [147](#)

Nudge menu

 Nudge menu, [229](#)

 Open nudge options, [229](#)

 Nudge guideline to the right, [229](#)

 Nudge guideline to the left, [229](#)

 Nudge guideline to the vehicle's position, [230](#)

 Save nudged guideline group, [229](#)

 GPS drift compensation, [231](#)

1.3.3. Navigation bar icons

 System information, [127](#)

 Guidance, [128](#)

 GPS information, [135](#)

 System diagnostics, [138](#)

 Task information, [140](#)

1.3. Icon descriptions



Auto section control, [234](#)



Switch box, [119](#)



ISOBUS universal terminal, [237](#)



Cameras, [47](#)



Yield monitor



Weather station, [239](#)



Norac boom height control, [53](#)



Plot planter, [243](#)



Sprayer,  Seeder



Spreader,  Scraper



TAP, [3](#)



Inventory manager, [248](#)



Setup screen, [17](#)

1.3.4. View controls



Select mode, [128](#)



Display headland turn alarm, [212](#)

 Toggle guidelock mode, [195](#)

 Re-center/pan, [35](#)

 Select visible map layers, [132](#)

 Toggle map view mode, [133](#)

 Zoom out/in, [134](#)

1.3.5. Other icons

 ISOBUS shortcut, [48](#)

 Master switch, [121](#)

 Auto steer engage, [219](#)

1.4. Starting the display

1. Connect the display to a power supply. Ensure associated devices (such as GPS (Global Positioning System) and ECU (Electronic Control Unit)) are connected.
2. X25/X35: Press and hold the green ON/OFF button on the rear of the display for a few seconds to start the display. XD/XD+: Press the button on the left side of the display to start the display.

3. To change the language on the display, select

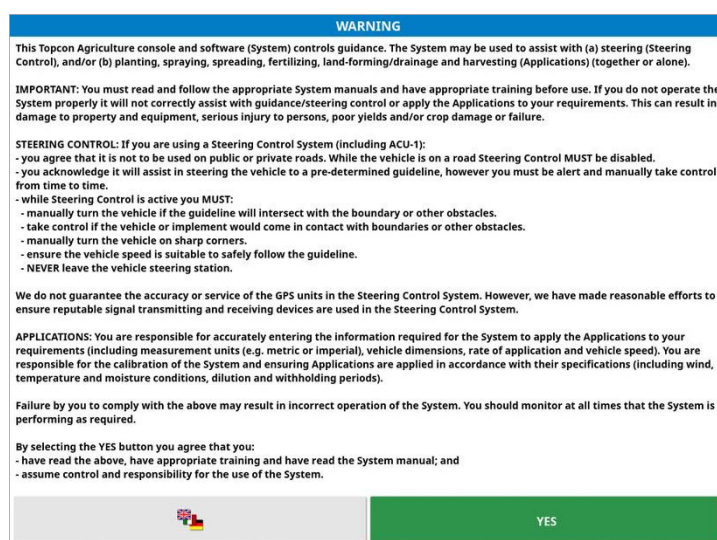

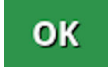
4. Use the scroll bar, or slide a finger down the list, to see more languages. Confirm the selection .

The Warning Screen displays in the chosen language.

5. Read the Warning Screen and if you agree select **YES**.

Note: Selecting Yes confirms your understanding and accepts your responsibility for liabilities described in the Warning Screen.

The display may display the following warning.

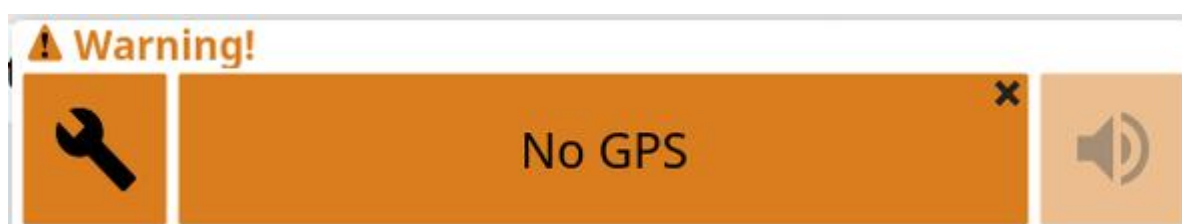

6. To acknowledge the alarm, press the center of the alarm window.
7. Confirm the GPS receiver is connected correctly and communicating.

Note: If the warning appears again, this should be remedied during setup by referring to [Setting up GPS, page 59](#).

1.4.1. Display power LED (X35 only)

The right hand side LED, located at the top of the display, turns green when the Horizon software starts up. If power is lost, the LED turns red until the display has successfully shutdown.

1.5. Shutting down or restarting the display

X25/X35

To shut down or restart the display, swipe up from the base of the screen to display the display toolbar and select the off icon. The system will ask if you want to power down or restart.



Alternatively, to shut down the display, briefly press the green ON/OFF button.

The system will ask if you want to power down. Select **Yes** to turn off or **No** to continue working.

Note: Pressing and holding the green ON/OFF button will also shut down the display, however data may be lost and this method is not recommended.

XD/XD+

To shut down the display, press the button on the left side of the display.

To restart the display, swipe up from the base of the screen to display the display toolbar and select the off icon. The system will ask if you want to restart.



1.6. Using the display toolbar



The display toolbar is displayed by swiping upwards from the base of the screen.



Power off: Shuts down the display. (X25/X35 only)



Help hint: Displays the names of the user interface elements on the screen. Question marks appear on the screen next to the icons. Select the screen element showing a question mark to view the names.



USB eject: The USB port can be used to import data to and export data from the display. Before removing the USB, always disconnect first by touching the **USB eject** icon. A message will display that it is safe to remove the USB.



Screenshots: Use the **screenshot** icon to take screenshots (which are stored on the USB). Press the USB eject icon before unplugging the USB.



Screen capture video: Pressing this button starts a video recording of the display screen. A USB must be inserted into the display to begin recording. A red border shows around the screen to indicate active video. Press the button again to stop the recording and export it to USB. The **USB eject** button **MUST** be pressed prior to removing the USB.



Manage global home screens: Enables Operation screen layouts to be saved. This may be useful to de-clutter the Operation screen or

quickly return to displaying required information. Display/hide the required views on the Operation screen and select this icon, then **Save Home Screen** to save the layout.



Go to home screen: Displays a list of saved global home screens or toggles between saved screens. See **Global home screen mode** on [page 33](#) to select the required option.



Brightness control: Adjusts the brightness of the display. Use plus or minus to adjust display.



Day/night color scheme: Changes the display between the day and night color scheme. Settings are Day, Night and Auto. Auto mode will set the color scheme automatically, depending on light conditions.

Chapter 2 – User Interface Description

2.1. Switch between setup and operation screen

The display has two main screens; the Setup screen and the Operation screen.

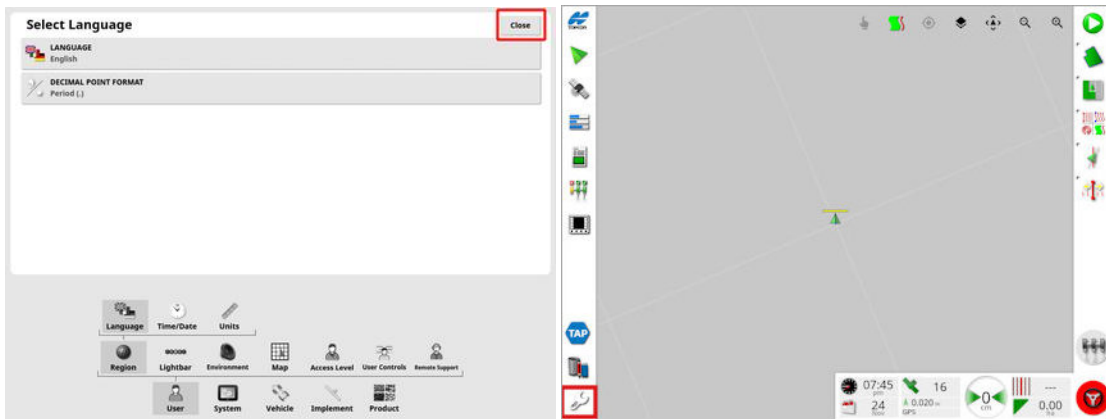

Use the highlighted buttons to switch between the screens.

Note: On XD and XD+ displays, the guidance map is not visible unless either 'Tasks' or 'Guidelines' are licensed and enabled.

2.2. Setup screen controls

The Setup screen has the following types of controls:

Menus

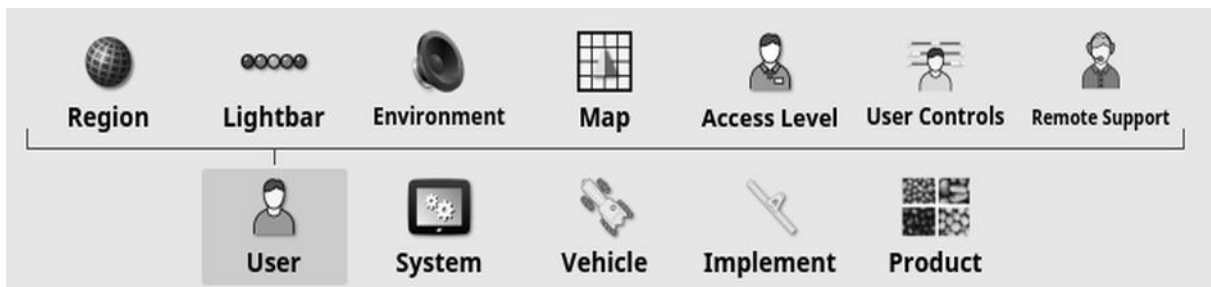

Menu items are selected from the base of the screen to display the next level of sub-options. When features are enabled, more items may appear in the menus.

Option lists



Selecting menu items will typically display a list of options at the top of the screen. As features are enabled, more options may appear.

Selection lists



Selection lists are used to choose one or more items from a list. A message is displayed if too many items are selected in a multiple choice list. Selections must be confirmed using the OK button.

Cancel and confirm buttons

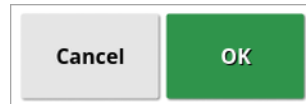

These buttons are used to cancel or confirm an entry or a selection. One of the buttons must be selected to progress from any screen displaying them.

Keyboard and number-pad



Letter and number keypads are used to enter alphanumeric characters or numeric characters. Entries must be confirmed.

Wizards

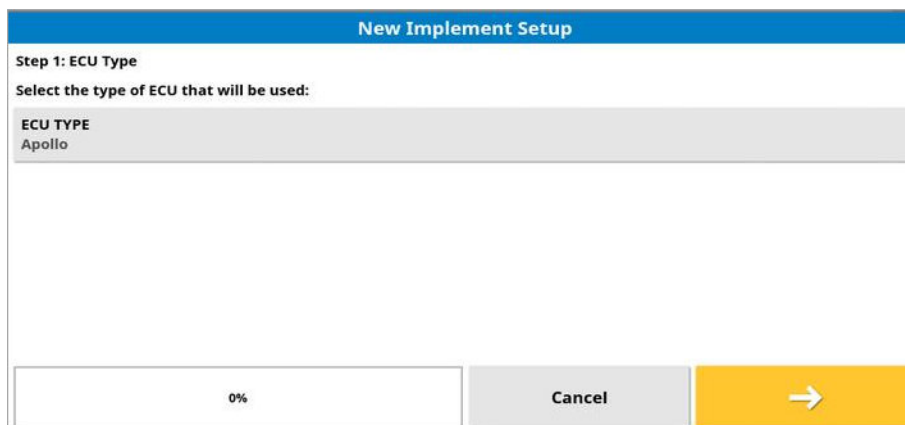

Wizards are used to guide the operator through a complex configuration of the system by answering a series of questions. The answers provided determine which questions will follow.

2.3. Operation screen controls

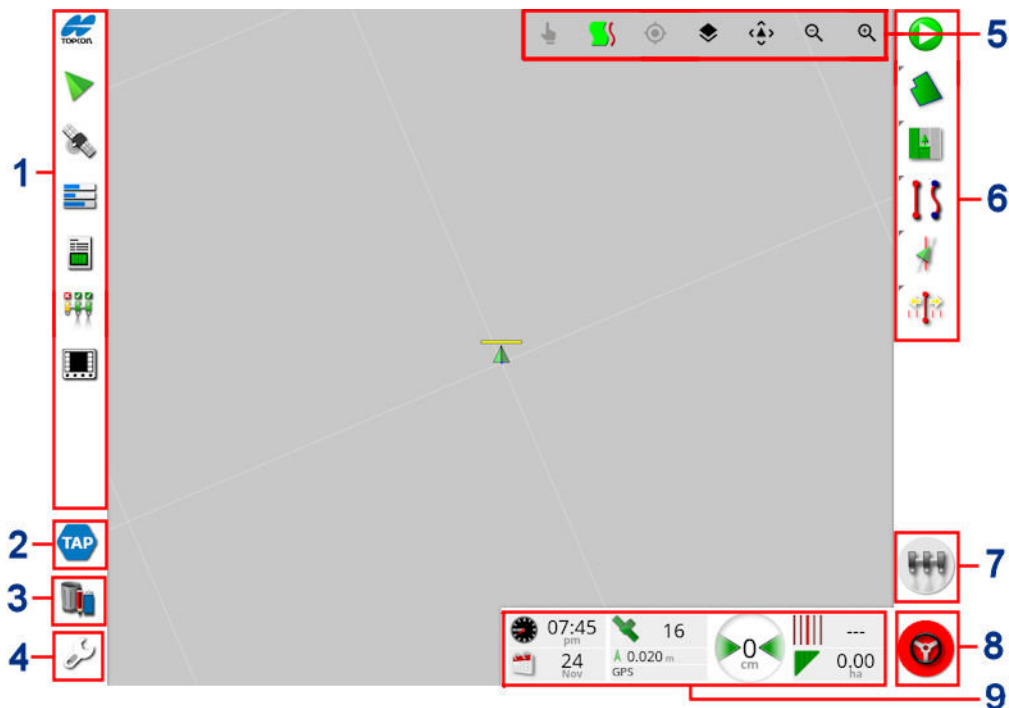

- 1 Navigation bar:** Opens mini-views to access other parts of the system. See [Using mini-views, page 125](#).
- 2 TAP:** Opens the TAP login screen or Horizon Marketplace. See [Using Topcon Agriculture Platform \(TAP\), page 3](#).
- 3 Inventory manager:** Enables management of vehicles, implements, fields, tasks, guidance lines and so on. See [Inventory Manager, page 248](#).
- 4 Setup screen:** Switches to the Setup screen.
- 5 View controls:** Allows the user to control what is displayed on the guidance map and how it displays. See [Using view controls, page 129](#).
- 6 Guidance toolbar:** Provides tools used to control guidance.
- 7 Master switch:** Turns product application on and off if 'virtual master switch' has been enabled during implement setup. See [Setting up the master switch, page 121](#).

- 8 **Auto steer engage:** Turns auto steer on and off.
- 9 **Dashboard:** Provides selected information from the system for monitoring. See [Monitoring on the dashboard, page 142](#).

2.3.1. Implement color indicators

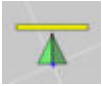

This indicates the position and direction of the vehicle and its implement. The implement color indicates product application status:

- **Red:** Section is off.
- **Blue:** Section is inhibited (on and not flowing, typically due to low speed or pressure).
- **Yellow:** Section is on and not flowing intentionally (typically due to auto-section control stopping the flow).
- **Green:** Section is on and flowing.
- **Orange:** Section is on and not flowing unintentionally or OFF but still flowing unintentionally (typically due to a delay in the time it takes for the flow to start up).

Chapter 3 – Quick Setup Guide

This chapter provides a quick overview to installing software onto the display, setting up the basics and operating the display.



WARNING: Before operating the display for the first time, the complete manual should be read to become familiar with all safety and operational issues.

3.1. Firmware / software update instructions

CAUTION: Updating the display requires the use of a USB. If the USB contains existing data, this may affect the update procedure and cause corruption of the display software. Prior to using the USB, ensure it is blank by plugging it into a PC, right clicking on the USB in File Explorer and selecting **Format**. Ensure **Quick Format** is ticked and press **Start**.

USBs with 8 to 16 GB of storage space provide the most reliable results.

Note: When setting up a new display, to ensure the latest firmware and software is loaded, check the currently released firmware and software versions via the MyTopcon NOW! app. (Search for 'Dealer current software versions' on the app.) If both the firmware and software require updating, the firmware **MUST** be installed first. The firmware update procedure is the same as for software.

1. Check the current firmware and software versions installed on the display using the System Information screen (see [Viewing system information, page 127](#)). Ensure the installed 'Main PMIC Firmware', 'CPU PMIC Firmware' and 'Co-Processor Firmware' are the correct versions for the installed 'Software Version' bundle.
2. On a Windows machine, unzip the installation ZIP file into the root folder of a recently formatted USB flash drive.
3. Safely eject the USB flash drive from the Windows machine.
4. Plug the USB flash drive into the powered-down display.
5. Power up the display.
6. Go to the Setup screen (via the spanner button in lower left corner).



7. Select **System**  / **Utilities**  / **PROVISION USB FOR UPGRADE** or **CONSOLE SOFTWARE UPGRADE** and select **Yes**.
8. Press the OK button to restart the display and automatically begin the software update.

The installation procedure will start automatically and will take a few minutes.
9. The display may provide the option to restore all user data to the state it was before the upgrade. **CAUTION:** Selecting **No** will delete all data saved on the display. The display will restart automatically.
10. After the display starts up, the software is ready for use.

3.2. Getting started



To configure the system:



1. Connect a GPS receiver to the display.
2. Go to the Setup screen (via the spanner button in lower left corner).

3. Select **System**  / **GPS**  and select:
 - The GPS receiver that is being used (see [page 59](#)).
 - The Correction Source required (see [page 61](#)).

4. Select **System**  / **Serial Ports**  and select the serial port on which the GPS receiver is connected (see [page 69](#)). (X25/X35 only)

















5. Once the system receives GPS data for the first time, it will prompt for configuration of the local time. Accept the current time or modify it to your local time.

6. Select **Vehicle**  / **New**  and create a new vehicle profile by selecting the appropriate model from the factory profile. Check and if needed modify the geometry of the vehicle (see [page 96](#)).

7. Select **Implement**  / **New**  and create a new implement profile by selecting the appropriate ECU type. If you select ASC-10 or Apollo as your ECU type, you will be guided through the steps to connect and configure all ECUs on your implement.

8. Check and if needed modify the geometry of the implement (see [page 112](#)).

9. Go to the Operation screen (via the Close button in the Setup screen).

10. Select the Task button  (via the top button on the guidance toolbar at the right hand side) to quickly start work without having to set up a client, farm, field etc (see [page 158](#)).
11. To enable Auto Steering, go to Setup screen, **System**  / **Features**  / **Guidance**  / **AUTO STEER** (see [page 219](#)).
12. To enable Auto Section Control, go to Setup screen and:
 - Create or load an implement.
 - In **Implement**  / profile / **Section Control**  / **Sections**  configure the number of sections and their width (see [page 117](#)).
 - If required, change the section timing in **Implement**  / profile / **Section Control**  / **Timing**  (see [page 118](#)).
 - If required, configure a physical or virtual switchbox in **Implement**  / profile / **Section Control**  / **Section Switch**  (see [page 119](#)).
 - Enable the Auto Section Control feature in **System**  / **Features**  / **Implement**  / **AUTO SECTION CONTROL** (see [page 51](#)).
13. To control any of the enabled features from the Operation screen, use the buttons on the Navigation bar down the left hand side of the screen. Those will open ‘mini-views’ of the features (see [page 125](#)).
14. To expand a mini-view to full screen (if the feature supports that), drag the mini-view to the right onto the main screen area.
15. Press , then select **Done** to complete the task.

Chapter 4 – Regional and User Settings

On the Setup screen, the **User** menu option provides the following menu items:

- **Region:** Selects the language, time/date and units. See [page 27](#).
- **Lightbar:** Sets operation of the LED bar for guidance use. See [page 31](#).
- **Environment:** Sets up display audio, button clicks etc. See [page 33](#).
- **Map:** Sets how maps work on the Operation screen. See [page 35](#).
- **Access Level:** Selects access levels to determine which controls are accessible. See [page 37](#).
- **User controls:** Defines which controls are accessible for different users. See [page 38](#).
- **Remote support:** Allows support personnel to remotely access and control display functions. See [page 40](#).

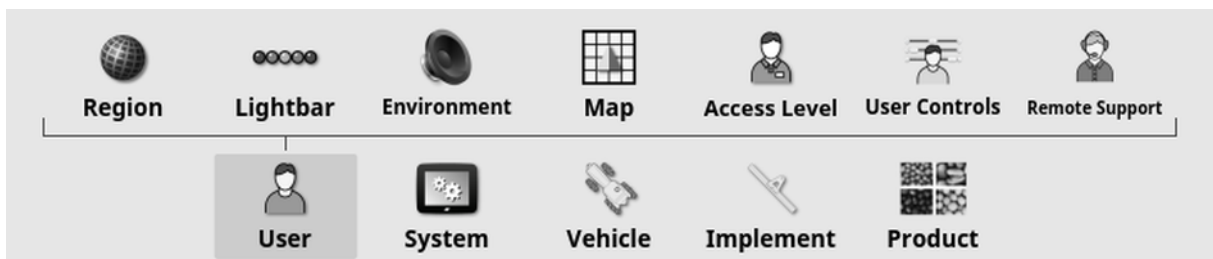

4.1. Setting the region

4.1.1. Language setup

The language displayed on the display may be changed if required and decimal separators may be represented by a period or a comma.

To set the language or decimal point format:

1. Select **User**  / **Region**  / **Language** .



- **Language:** The user interface can be displayed in a choice of languages. Use the scroll bar to see the available languages. Confirm the selection. The display will restart.

Note: The language may also be changed on the warning screen at

startup by selecting



- **Decimal point format:** A decimal point may be represented by a period (.) or a comma (,).

4.1.2. Time/date setup

The date information is used on the display for task start and end dates, as shown on task reports. The current date is supplied from the GPS signal.

Note: Both time and date will not work if there is no GPS signal.

The current date and time can be displayed on the Operation screen by selecting the Topcon icon in the top left of the display (or shown on the dashboard).

To set date and time information:

4.1. Setting the region

1. Select **User**  / **Region**  / **Time/Date**  .

Time/Date Setup	
 DATE FORMAT 22 Jan, 2020	
 TIME FORMAT 12-hour (2:30pm)	
 SET CURRENT DATE 22/1/2020	
 SET CURRENT TIME 11:47 am	







- **Date format:** Select the required date format from the list.
- **Time format:** Twelve hour time (2:30pm) or Twenty four hour time (14:30).
- **Set current date:** This setting can be used if the date set by GPS is incorrect. This overrides the GPS date.
- **Set current time:** Current time (does not change automatically for daylight saving). Note that -/+ will change time incrementally.

4.1.3. Units setup

The units options set the displayed units of measurement (metric or imperial), units for pressure, area and products, the latitude/longitude format and the application rate increment type.







To set unit information:

1. Select **User**  / **Region**  / **Units**  .

Regional Units	
 UNITS Metric	 APPLICATION RATE INCREMENT TYPE Fixed Rate
 LATITUDE/LONGITUDE FORMAT DMS	
 PRESSURE UNITS Default (kPa)	
 SHORT DISTANCE UNITS Default (Metres)	
 AREA UNITS Default (ha)	
 VOLUME UNITS (DRY) Default (Kilograms)	

- **Units:** Metric, Imperial (US) or Imperial (UK). The United States (US) and United Kingdom (UK) imperial options are provided because gallons, fluid ounces and bushels have different measurements in the US and the UK. **Note:** Changing this setting will not override the selection of individual units (Pressure, Area etc.) that have been changed.
- **Latitude/longitude format:** Standard (decimal degrees: 45.54) or DMS (Degrees, Minutes, Seconds: 45°, 23' 36").
Note: Selecting **Default** for all other unit types selects the appropriate setting for the option selected in **Units**.
- **Application rate increment type:** Fixed rate or Percentage of Rate Preset1. This option changes the behavior when the operator presses the up/down buttons to change the requested product application rate. These can either change by a fixed rate or by a percentage of the rate set for **RATE PRESET1 (SPRAY RATE** on an Apollo Sprayer).

4.1. Setting the region

1: 17-17-00-16		1: 17-17-00-16	
 PRODUCT NAME 17-17-00-16	 PRODUCT NAME 17-17-00-16	 RATE INCREMENT 5.00 kg/ha	 RATE INCREMENT 5 %
 RATE PRESET1 20.00 kg/ha	 RATE PRESET1 20.00 kg/ha		

See the Spreader, Sprayer or Seeder operator manuals for more information.

4.2. Setting up the lightbar

During operations, the virtual lightbar on the top of the guidance screen can show how far the vehicle is deviating from the set guideline.

1. Select **User**  / **Lightbar** .

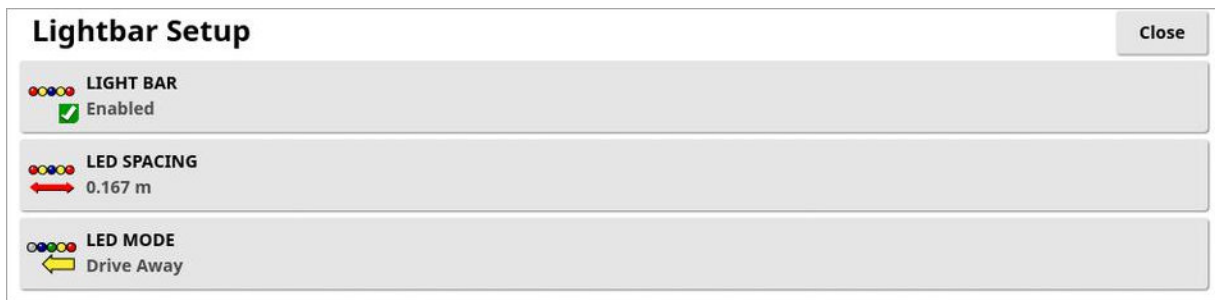

- **Light bar:** Enabled or disabled.
- **LED spacing:** Sets the ground distance from the wayline (guideline) that each LED represents. If the LED spacing is set to 10 cm (0.1 m), the following behavior is observed:
 - The center LED is blue and will be illuminated all the time (unless the cross track error is 100 cm or more). When on the wayline by less than 10 cm (+ or -) that is the only LED that is illuminated.
 - Once you reach a cross track error of 10 cm, the next LED (green) will also illuminate.
 - At 20 and 30 cm another green LED illuminates.
 - Yellow LEDs illuminate at 40, 50 and 60 cm.
 - Red LEDs illuminate at 70, 80 and 90 cm.
 - Once the cross track reaches 100 cm or more, all LEDs turn off except for one red LED on the far side of the display.
- **LED mode:**
 - **Drive away:** Activates the LEDs on the side of the vehicle veering away from the guideline. Drive away from the lit LEDs to move back to the guideline.
 - **Drive towards:** Activates the LEDs on the side of the vehicle veering towards the guideline. Drive toward the lit LEDs to move

4.2. Setting up the lightbar

back to the guideline.

4.3. Setting up environment

Sets up display interactions.

1. Select **User**  / **Environment**  .

Environment Setup	
	AUDIO VOLUME 10%
	BUTTON CLICKS Disabled
	ALARM AUDIO Disabled
	GLOBAL HOME SCREEN MODE Select
	AUTOMATIC STEERING STATUS WINDOW Auto Open Only
	TOOLBAR BUTTON SIZE Small

- **Audio volume:** Sets the volume of display sounds.
- **Button clicks:** Enable or disable sounds when making a selection on the display.
- **Alarm audio:** Enables sounds when an alarm is triggered.
- **Global home screen mode:** **Select** from a list of saved global home

screens or **Toggle** between saved screens when the  icon is selected on the display toolbar. See **Manage global home screens** on [page 15](#).

- **Automatic steering status window:** Displays a Steering Status

window when the Auto Steer Engage button  is selected on the Operation screen if the steering is unable to engage. The Steering Status window displays issues that may be preventing the steering from engaging. If **Auto open and close** is selected, the Steering Status window will automatically close once any issues preventing the steering from engaging have been resolved.

4.3. Setting up environment

Note: The Steering Status window may still be displayed via the **Steering Options Menu / Auto Steer Status** (see [Auto steer status, page 219](#)) if this setting is disabled.

- **Toolbar button size:** Changes the size of the buttons on the Operation screen.

4.4. Setting up map options

Sets how maps work on the Operation screen.

1. Select **User**  / **Map**  .

Map Options Setup	
	POINT OF FOCUS Implement
	MAP PANNING Enabled
	MAP FOCUS AUTO-SHIFT Disabled
	PAUSE BOUNDARY RECORDING WITH MASTER Disabled
	VISUAL REFERENCE LINE LENGTH 0.0 m

- **Point of focus: Vehicle** places the vehicle at the center of the screen and **Implement** places the implement at the center of the screen.
- **Map panning:** Allows the screen to move around in a map when the user slides a finger across the screen. Enabling this option places the map panning icon  into the view controls. See [Using view controls, page 129](#). Touching this icon re-centers a panned map to the current location of the vehicle.
- **Map focus auto-shift:** Sets the vehicle in the center of the available screen when mini-views are open.
- **Pause boundary recording with master:** If the master switch is turned off while a boundary is being recorded, the boundary recording is paused. Turning the master switch back on resumes the boundary recording. This may be useful to automatically pause boundary recording if product application is paused to maneuver in a tight corner or deviate around an object. Note that boundary recording may still be manually paused (see [Setting a new boundary, page 168](#)).

4.4. Setting up map options

- **Visual reference line length:** Provides a display marker at the user prescribed distance in front of the vehicle icon to help accurately acquire the wayline after a turn when using manual guidance.

4.5. Setting access level

Setting the access level determines which controls are accessible to the user. The accessibility of the controls can be configured on the user controls screen (only available when Expert is selected as the Access Level). See [Setting user controls, page 38](#).

To change the access level:

1. Select **User**  / **Access Level**  .

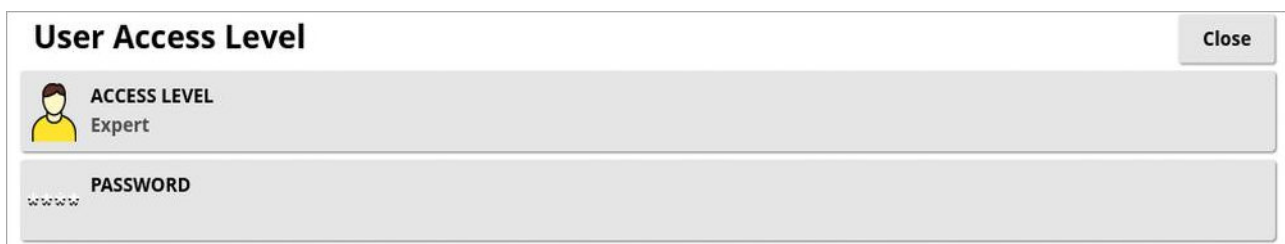

User Access Level Close

ACCESS LEVEL
Expert

PASSWORD
w@r@w@w

The Access Level may be set at Easy, Standard or Expert. A password may be set for the Standard and Expert levels to prevent inexperienced users from accessing higher levels.

The display will turn on in whichever level was set before turning it off.

4.6. Setting user controls

This screen is only available when Expert is selected as the Access Level. See [Setting access level, page 37](#).

Access to display controls can be configured by setting the user controls. There are three levels of access available: Easy, Standard and Expert.

- **Easy:** This mode is recommended for everyday operator use. It allows access to all basic controls and some status information. This provides an uncluttered and easy to learn user interface.
- **Standard:** This mode has extended functionality, intended for more experienced users who want more control of the functions they are using. This includes more advanced controls (for example; clearing coverage, deleting items).
- **Expert:** This mode has all the configuration options for setting up a vehicle, implement, GPS receiver, etc. It can also be used for normal farming by power users who want everything visible at once.

To define the user controls:

1. Select **User**  / **User Controls**  .

User Controls				Close
Control	Easy	Standard	Expert	
Miniview: System Information	<input checked="" type="checkbox"/>	<input checked="" type="checkbox"/>	<input checked="" type="checkbox"/>	
Miniview: GPS	<input checked="" type="checkbox"/>	<input checked="" type="checkbox"/>	<input checked="" type="checkbox"/>	
Miniview: Diagnostics	<input checked="" type="checkbox"/>	<input checked="" type="checkbox"/>	<input checked="" type="checkbox"/>	
Fullview: Diagnostics	<input checked="" type="checkbox"/>	<input checked="" type="checkbox"/>	<input checked="" type="checkbox"/>	
Miniview: Tasks	<input checked="" type="checkbox"/>	<input checked="" type="checkbox"/>	<input checked="" type="checkbox"/>	
Miniview: ASC	<input checked="" type="checkbox"/>	<input checked="" type="checkbox"/>	<input checked="" type="checkbox"/>	
Miniview: Implement Controller	<input checked="" type="checkbox"/>	<input checked="" type="checkbox"/>	<input checked="" type="checkbox"/>	
Miniview: Switchbox	<input checked="" type="checkbox"/>	<input checked="" type="checkbox"/>	<input checked="" type="checkbox"/>	
Miniview: Universal Terminal	<input checked="" type="checkbox"/>	<input checked="" type="checkbox"/>	<input checked="" type="checkbox"/>	
Miniview: Cameras	<input checked="" type="checkbox"/>	<input checked="" type="checkbox"/>	<input checked="" type="checkbox"/>	

Reset Preview Preview

The accessible controls for the three levels are set by default. They may be edited as required by pressing the tick or cross for each option.

The **Reset** button enables settings to be returned to either the factory defaults or to the settings the display had when it was powered up.



The **Preview** buttons enable you to see how the settings will look in Easy or Standard mode, without leaving Expert mode.

4.7. Setting up remote support

Remote support enables a support person to remotely access and control the display via the Topcon Support app. Internet access is required. See [Setting up Wi-Fi, page 90](#).

4.7.1. Setting up support

To configure remote support on the display, the support person must supply the PIN number that is displayed at the top of their Topcon support app. This will allow the display to connect remotely to the Topcon Support app.

1. Select **User**  / **Remote Support**  , then click on the plus symbol at the top right of the screen.

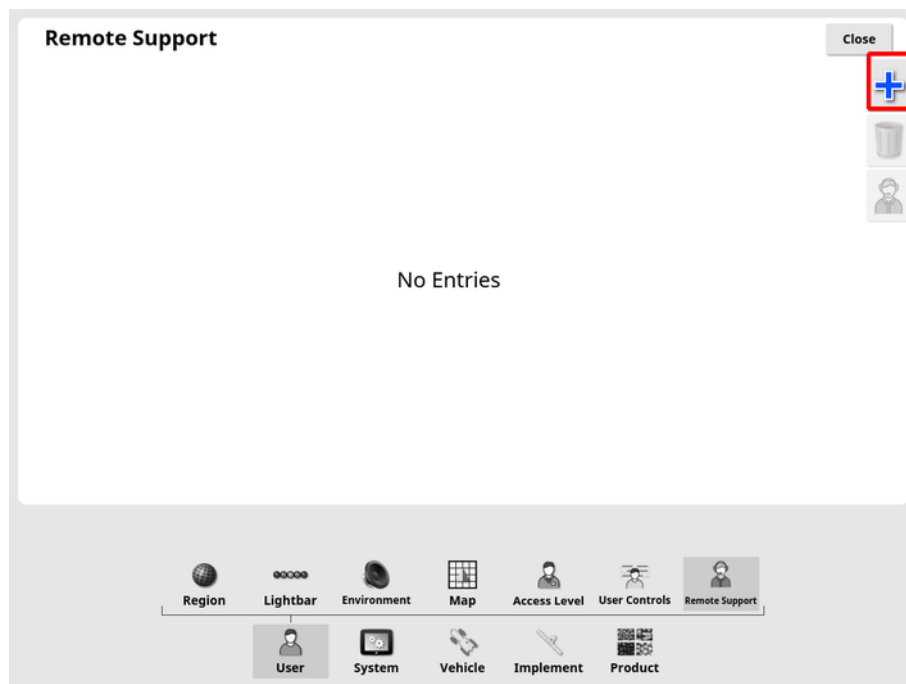

The Add Support Desk window is displayed.

2. Enter the supplied PIN number in the **DESK PIN** field and confirm.

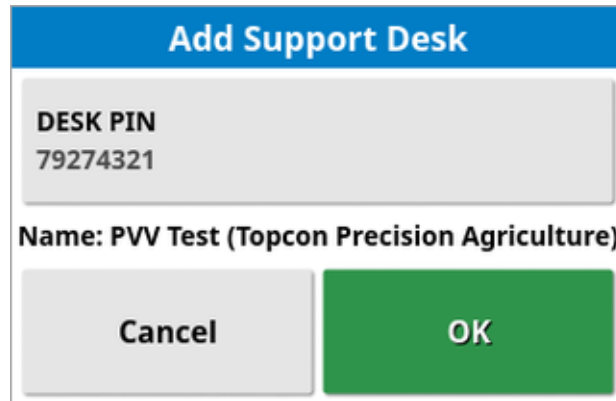

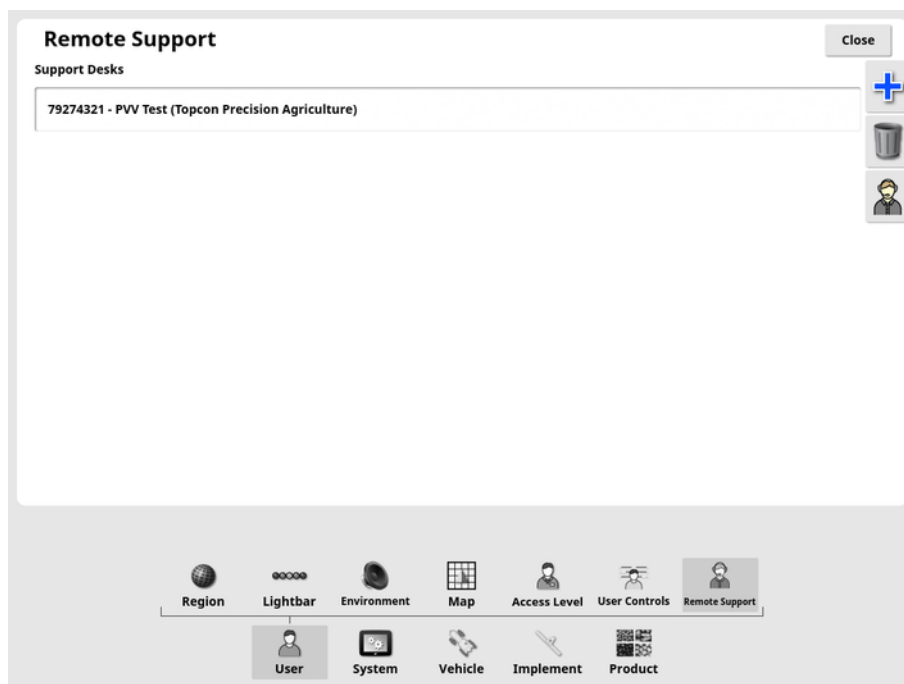

The display connects with the Support person's device and displays their name.

The configured support person is displayed in the list of Support Desks.



4.7.2. Requesting support

1. To request remote support, select **User**  / **Remote Support**  .
A list of configured support desks is displayed.
2. Press the required support option from the list of support desks and
then select the request support icon .

4.7. Setting up remote support

The Request Support window is displayed.

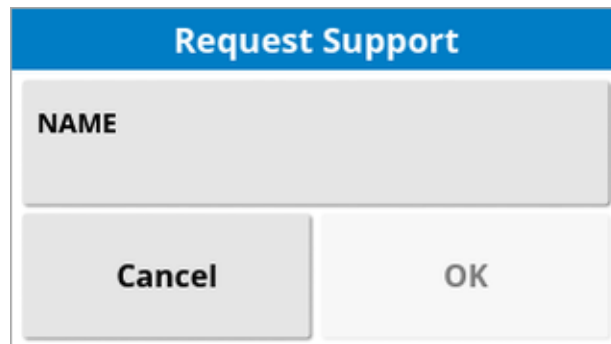

3. Enter an identifying name and confirm.

A support request is sent to the selected support desk.

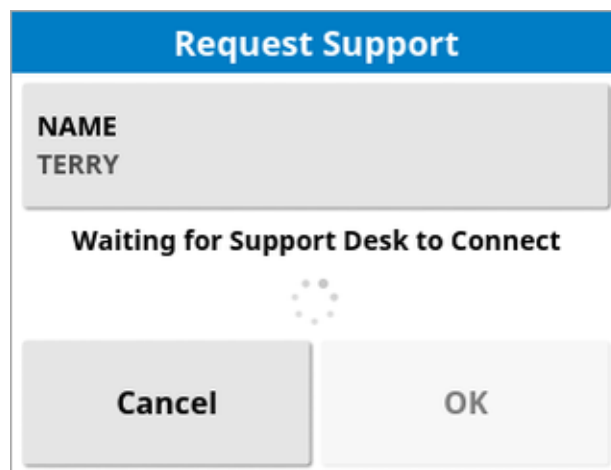

Once the support desk responds to the support request, they have access to and control of the display (excluding steering, master switch and Universal Terminal).

Note: Every fifteen minutes, a window displays to ask if you would like to continue the remote support session. Selecting **No** terminates the session.

Chapter 5 – System Setup

This chapter explains how to set up system elements such as GPS connections, alarms and optional features.

The **System** menu option provides the following menu items:

- **System:** Enter a name to identify the display, log into TAP or set the resolution for task data being exported. See [page 44](#).
- **Features:** Enables or disables optional features. See [page 46](#).
- **GPS:** Sets up the functionality of the connected GPS receiver. See [page 59](#).
- **Serial Ports:** Selects the display serial port assigned to a particular function. See [page 69](#). (X25/X35 only)
- **Alarms:** Sets alarm functionality. See [page 70](#).
- **Flag Points:** Selects icons and labels for flag points. Flag points show obstacles or other land features on a guidance map. See [page 81](#).
- **Cameras:** Allows the operator to monitor connected cameras on the display. Refer to the Camera Monitor operator manual.
- **ISOBUS:** Allows interaction with ISOBUS compliant ECUs via the ISOBUS Universal Terminal. See [page 82](#).
- **Utilities:** Allows a USB to be provisioned to upgrade software. See [page 89](#).

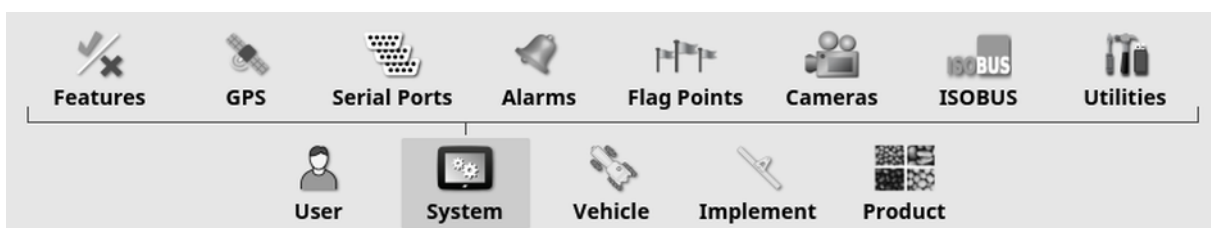

5.1. Setting system settings

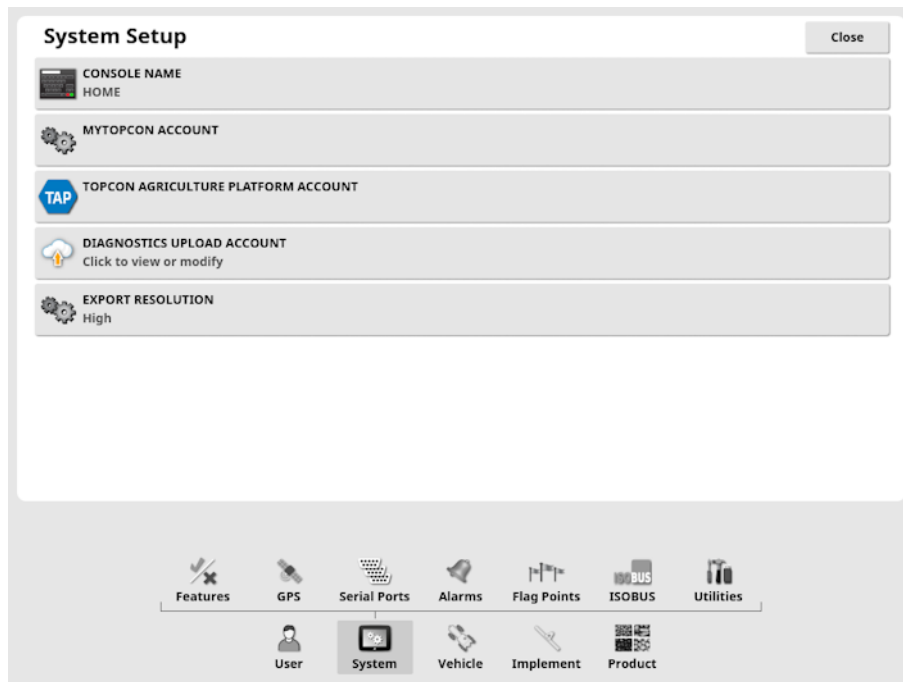

- **Console name:** Enter a name to identify the display. This is the name used by TAP and displayed on the XTEND app on the mobile device when choosing a display to view. See [XTEND setup, page 53](#).

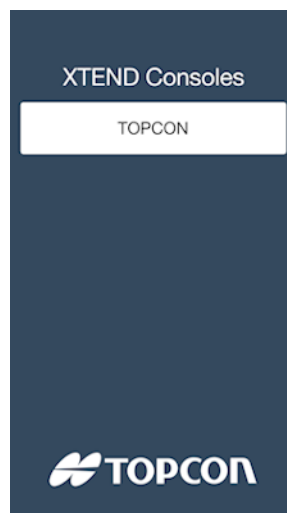

- **MyTopcon account:** Select this option to use your MyTopcon NOW log in to enable the use of trial licenses for Horizon features. See [Licenses setup, page 46](#).

- **Topcon Agriculture Platform account:** Select this option to log in to TAP or to change TAP accounts. See [Using Topcon Agriculture Platform \(TAP\), page 3](#).
- **Diagnostics upload account:** Enables the default settings for the Topcon FTP server to be changed, if required. This should only be done if directed by Topcon support personnel.
- **Export resolution:** This setting can be used to reduce the file size of data being transferred from the display to USB or TAP, if required. This is achieved by transferring fewer data points, which will result in lower resolution coverage data.

5.2. Setting features

The **Features** menu option provides the following menu items:

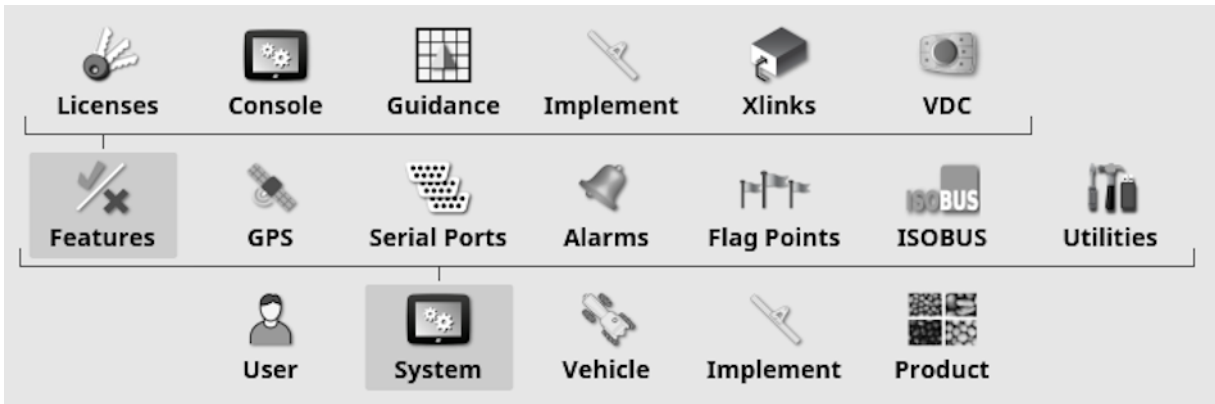



5.2.1. Licenses setup

Setup licenses for optional features.

Note: Licences may be purchased remotely by your dealer via TAP and Horizon Marketplace, see [Viewing optional features via Marketplace, page 4](#). If that is not possible, the licences may be supplied via USB as shown below.

Note: A trial license is available for each feature, which may be enabled once (for 25 hours of usage within a 30 day period). A MyTopcon NOW account login is required. See [Setting system settings, page 44](#) to log in.

1. Select **System**  / **Features**  / **Licenses**  .

Licenses			Close
 EXPORT LICENSE DATA Click to export for B1-D8-48-48		 IMPORT LICENSE DATA Click to import	
Feature	Status	Expiry	
Cameras	Unlicensed	Free Trial	
Controlled Traffic	Unlicensed	Free Trial	
Headland Turns	Licensed	Unlimited	
Hypro ProStop-E	Licensed	Unlimited	
LH5000 Rate Sensor	Licensed	Unlimited	
MachineLink	Unlicensed	Free Trial	
Plot Planter	Unlicensed	Free Trial	
Water Conservation	Unlicensed	Free Trial	

- **Export license data:** Selecting this option exports a folder to a USB with information about the display and, if applicable, any existing licenses. The folder must be sent to the dealer to generate a new license file.
- **Import license data:** The dealer must supply the required licences to be placed on a USB. Insert the USB into the display and select this option to update the current licenses. **Note:** The features must still be enabled on other setup screens before they will be available.
Note: If a USB is not available to import the license codes, selecting **Unlicensed** in the **Status** column displays a screen where the codes may be entered manually.
- **Feature:** The complete list of optional features available for the display.
- **Status:** The current license status for each feature.
- **Expiry:** Shows the time until a licensed feature will expire or if a free trial is available.

Note: Pressing a heading in the table will reorder the list by the contents of that column.

5.2.2. Console setup

Configure display features.

5.2. Setting features

1. Select **System**  / **Features**  / **Console**  .

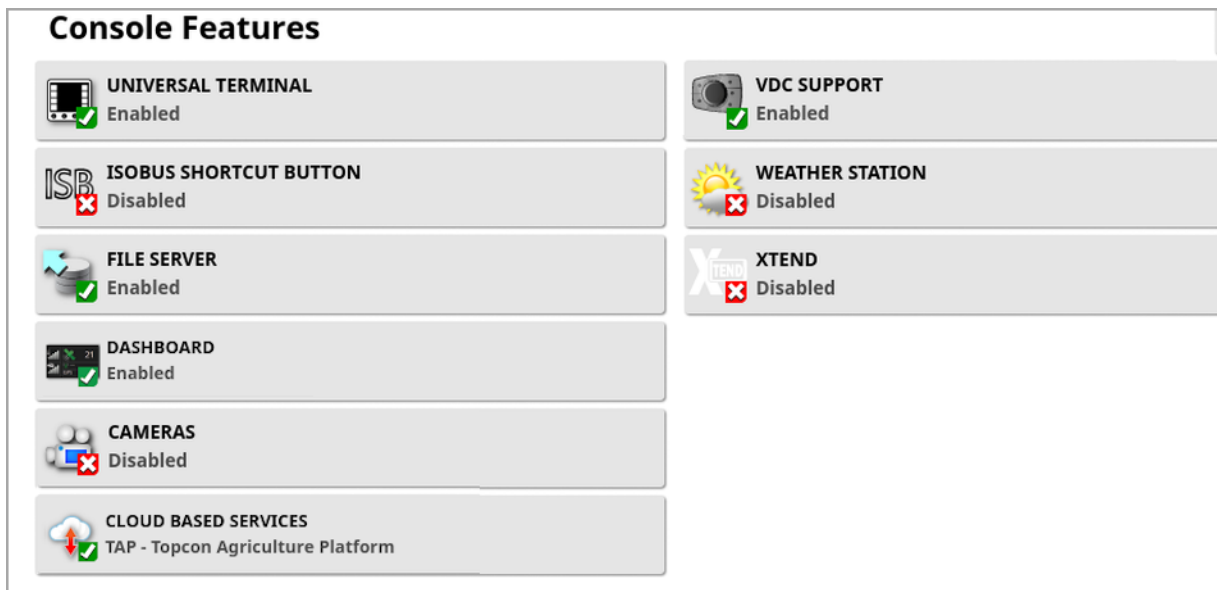

- **Universal terminal:** Enables the ISOBUS Universal Terminal server that allows interaction with ISOBUS compliant ECUs. See [Setting up ISOBUS / universal terminal, page 82](#).
- **ISOBUS shortcut button:** Adds a button on the operator screen above the master switch, which enables the operator to directly deactivate functions that were activated by an ISOBUS control. Pressing the button again will not restart the functions, but will permit them to be restarted manually via the standard mechanism for each function.



- **File server:** Can store files for an ISOBUS ECU if the ECU has file server capability. It allows implements and other profiles to be moved between ECUs. Files can be exported and imported using the USB.
- **Dashboard:** The dashboard on the operation screen can be disabled if required. See [Monitoring on the dashboard, page 142](#).

- **Cameras:** Allows the operator to monitor connected digital cameras on the display. Refer to the Camera Monitor operator manual.
- **Cloud based services:** Enables license subscription and file transfer via Topcon Agriculture Platform software. See [Using Topcon Agriculture Platform \(TAP\), page 3](#).
- **VDC support:** The VDC (Vehicle Display Controller) is an optional device that may be used to perform a selection of display functions. See [VDC setup, page 57](#).
- **Weather station:** Enables support for the AirMar 150WX Weather Station via the CAN NMEA2000 data output from the sensor. Select the CAN port to which the weather station is connected. An icon is added to the Navigation bar on the operation screen. See [Using weather station, page 239](#).
- **Tasks (XD/XD+ only):** Enables the tasks menu (if not already present due to guidelines being enabled). This also enables the field menu.
- **XTEND:** Using the XTEND technology, you can extend the user interface of your display to the screen of your mobile device. Get access to many of the Horizon software features directly on your mobile device, both within and outside the cab of your vehicle. Use your mobile device to perform calibration, diagnostics, tank fill and many other activities anywhere around your machine via the Horizon user interface. A dedicated Wi-Fi connection keeps your mobile device always in sync with the main display in the cab. The XTEND app (available in Android or iOS) is used in conjunction with the XTEND feature on the display. See [XTEND setup, page 53](#).

Note: If the display loses its connection with the mobile device before the XTEND session is properly exited, the system is placed into a safe state. All moving parts (pumps, drives etc) are stopped. ISOBUS ECUs are disconnected from the display UT and as a result will enter their own safe state. An alarm is displayed that must be acknowledged before the system will exit the safe state. To avoid this, press the 'Back' button on the toolbar to exit the XTEND session properly before exiting the app or moving out of Wi-Fi range.

5.2.3. Guidance setup

Sets the guidance system functionality.

1. Select **System**  / **Features**  / **Guidance**  .

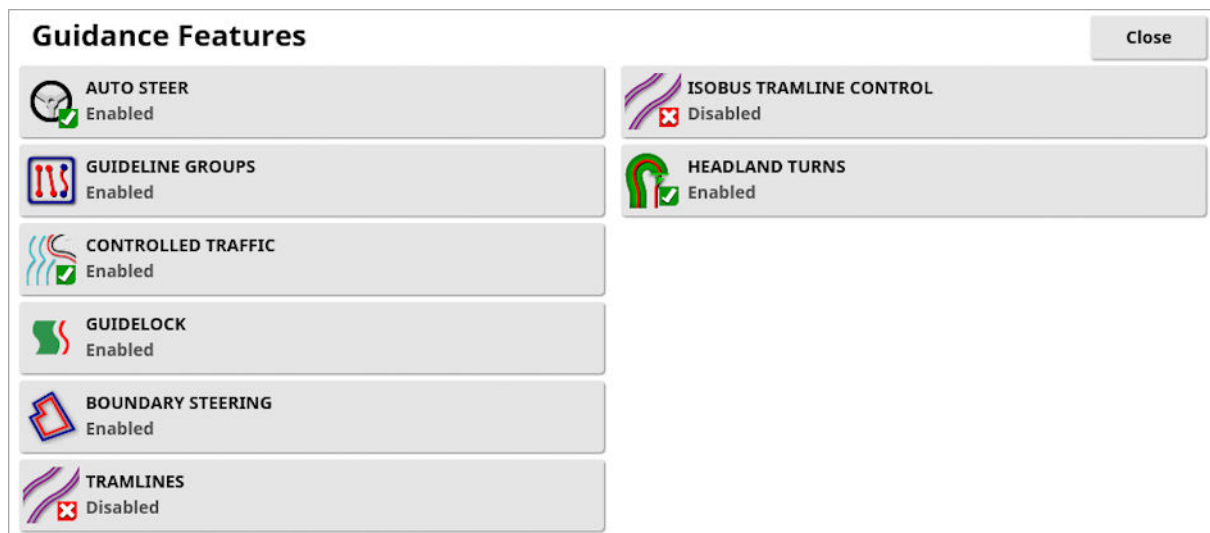

- **Guidelines** (XD/XD+ only): Enables guideline functionality (and also the field menu).
- **Auto steer**: Enables auto steering and can only be used on vehicles fitted with an auto steering system such as the AES-25.
Note: This option is only visible if a compatible GPS receiver is selected.
- **Guideline groups**: Enables guidelines to be created in groups. See [Guideline Groups, page 214](#).
- **Controlled traffic**: Controlled traffic enables planting the field and then harvesting using the same as driven lines over the next several years. This reduces the negative impacts of soil compaction on rainfall infiltration, rooting depth and crop yield. This feature enables an unlimited number of AB line or curves to be recorded in a single guideline group (increased from the standard twenty guidelines available). It also adds a new guidance mode; Project lines. See [Using project lines, page 198](#).











- **Guidelock:** Guidelock guidance mode is a coverage based guidance mode. It can be disabled if not required. See [Using guidelock guidance mode, page 195](#).
- **Boundary steering:** Enables a guideline to be generated from the boundary. See [Using boundary steering, page 196](#).
- **Tramlines:** Horizon software can display a visualization of tramlines. Tramlines display an indication of lines that the wheels travel along that should not be seeded. Tramlines are only a visual indicator, they do not control the implement operation. See [Setting up tramlines, page 203](#).
- **ISOBUS tramline control:** Tramline control leaves set paths unseeded for the tractor to drive when spraying or fertilising. If this option is enabled, tramline control can be configured via the UT interface for a connected ISOBUS ECU that has tramline control available.
- **Headland turns:** Provides the ability to autosteer around headland turns. See [Configure headland turns, page 206](#).

5.2.4. Implement setup

Sets up the functionality for the attached implement.

1. Select **System**  / **Features**  / **Implement** .

Implement Features Close

<div style="border: 1px solid gray; padding: 5px; margin-bottom: 5px;">  AUTO SECTION CONTROL <input checked="" type="checkbox"/> Enabled </div> <div style="border: 1px solid gray; padding: 5px; margin-bottom: 5px;">  AREA COUNTERS <input checked="" type="checkbox"/> Enabled (Stored per Task) </div> <div style="border: 1px solid gray; padding: 5px; margin-bottom: 5px;">  RESET TASK AREA COUNTERS <input type="checkbox"/> Prompt </div> <div style="border: 1px solid gray; padding: 5px; margin-bottom: 5px;">  NITROGEN SENSING <input checked="" type="checkbox"/> Disabled </div> <div style="border: 1px solid gray; padding: 5px; margin-bottom: 5px;">  VARIABLE RATE CONTROL <input checked="" type="checkbox"/> Enabled </div> <div style="border: 1px solid gray; padding: 5px;">  NORAC BOOM HEIGHT CONTROL <input checked="" type="checkbox"/> Disabled </div>	<div style="border: 1px solid gray; padding: 5px; margin-bottom: 5px;">  MACHINELINK <input checked="" type="checkbox"/> Enabled </div> <div style="border: 1px solid gray; padding: 5px; margin-bottom: 5px;">  LOCK SETUP MENU WHEN IMPLEMENT IS ACTIVE <input type="checkbox"/> Disabled </div> <div style="border: 1px solid gray; padding: 5px; margin-bottom: 5px;">  WEIGH SCALES <input checked="" type="checkbox"/> Enabled </div> <div style="border: 1px solid gray; padding: 5px;">  LH5000 RATE SENSOR <input checked="" type="checkbox"/> Disabled </div>
--	---

- **Auto section control:** Permits the system to turn sections on for new areas to be covered and off for areas that have already been covered (see [Using auto section control, page 234](#)).
- **Area counters:** Used with spreaders, sprayers and seeders to record data such as treated area, product used, operating time, average rate and productivity rate. Area counters are not available when using ISO implements or Xlinks.
 - **Enabled (Stored per task):** Area counters are stored separately for each task, (if a task is started and coverage laid, then another task is selected and coverage laid, going back to the first task displays the area counters from the first task).
 - **Enabled (Stored per implement):** Area counters continue across tasks, but loading a new implement displays new area counters. Reloading the first implement displays the area counters as they were when that implement was last used.

Note: Area counters can be enabled for both tasks and implements at the same time. Refer to the Spreader, Sprayer and Seeder operator manuals for more information.

Enabling area counters per task displays the **Reset task area counters** option:

- **Never:** The area counters must be reset manually, or they will continue to accumulate data.
 - **Prompt:** When a task is erased you will be asked if area counters should be reset.
 - **Auto:** Creating a new task or erasing a task will automatically reset the area counters.
- **Nitrogen sensing:** A Topcon real-time integrated crop monitoring and application system. Used to monitor in-field variability, treat on-the-go, or keep data for future analysis or prescription applications. CropSpec is displayed via the Universal Terminal (see [Using universal terminal \(ISOBUS\), page 237](#)), using a map overlay.

- **Variable rate control:** Works with a prescription map to vary application rates over the mapped areas (see [Configuring variable rate control, page 183](#)).
- **NORAC boom height control:** Automatically controls the height of the boom above the ground or the crop canopy. Requires NORAC sensors and Electronic Control Unit (ECU) to be installed. See [Using NORAC Boom Height Control, page 241](#).
- **MachineLink:** Enables coverage to be shared between multiple implements in the same field. See the MachineLink Installation and Operator's Manual for more information.
- **Lock setup menu when master switch is on:** Disables access to the setup menu when the master switch is on.
- **Weigh scales:** Enables the Horizon seeder controller software to display measured weight readings from Scale Link ECUs.
- **LH5000 rate sensor (X25/X35 only):** Allows a third party device to provide a real time RS232 rate input to the display. This can then be used with both liquid and granular controllers as an alternative to a Variable Rate Control (VRC) map. The serial port that the sensor is connected to must be selected. See [Setting up serial ports \(X25/X35 only\), page 69](#).

5.2.5. XTEND setup

Setup on the display

Note: It is recommended that a CL-10 or an EDIMAX AC 600 dongle is connected to the display for use with XTEND. Other dongles that do not have an external antenna may not provide adequate signal strength for operating outside the vehicle cabin. Configure the mobile device as a wireless hotspot and enable the Wi-Fi connection on the display. See [Setting up Wi-Fi, page 90](#).

Note: A console name must be entered. See [Setting system settings, page 44](#). This name is displayed on the XTEND app on the mobile device when choosing a display to view.

5.2. Setting features

1. Select **System**  / **Features**  / **XTEND** .

This screen identifies any external device that is currently paired with this display.

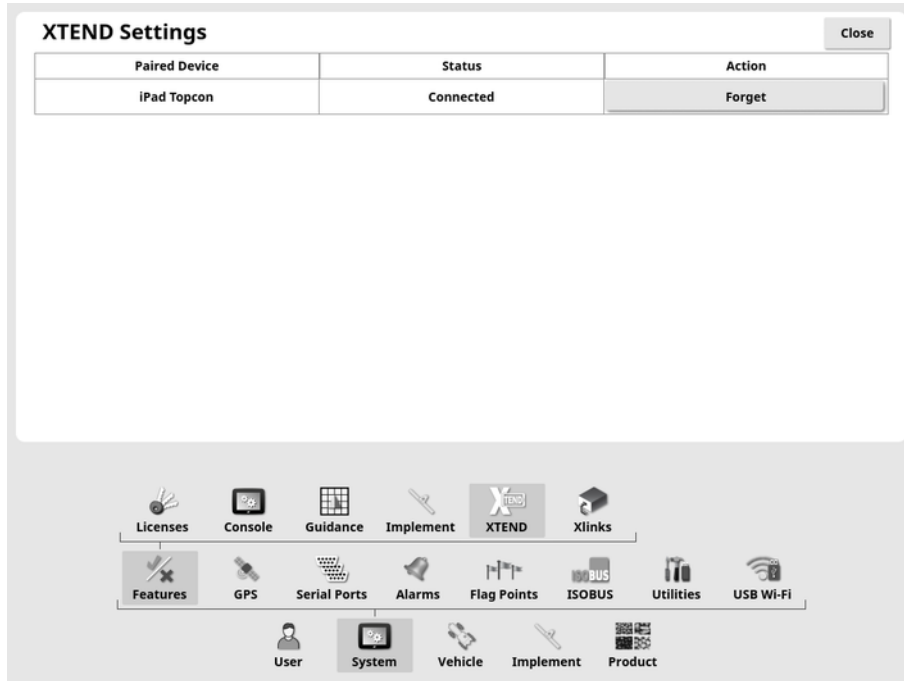

The **Forget** option prevents an external device from reconnecting to this display via XTEND, unless the display operator confirms the connection. If an XTEND device pairs with another display, the display operator must confirm prior to reconnecting.



Setup on the mobile device

The XTEND app is available for iOS and Android devices from the Apple and Google app stores. Configure the mobile device as a hotspot for use with XTEND.

XTEND example use cases

Note: Some functions are available when viewing XTEND on a tablet but not on a phone. When using a tablet, the entire controller screen is visible and all the functions that can be done on the display can also be performed on XTEND. The following functions can be performed via XTEND when using a phone:

Seeder:

- Tank calibration
- Tank fill
- Tank empty

Sprayer:

- Valve balancing wizard
- Flow meter calibration

Available when using a tablet:

Guidance / Universal Terminal:

- Display the guidance map at different zoom levels on the display and external device, or have one map layer displayed on the display and another displayed on an external device so you can see yield, applied rate for multiple tanks etc.
- Increase the viewable area of your display. Rather than show a mini view on the display, show that screen maximised and display the guidance view on an external device (or vice versa). Alternatively, two different screens related to one implement can be shown on the display and mobile device.
- When installing a wheel angle sensor, display the WAS position value on an external device when setting up the centre position for the sensor bearing shaft, to ensure the sensor is centered when the wheels are facing straight ahead.
- Enter boundary offset figures while measuring distances in the field.

Sprayer:

5.2. Setting features

- Check sprayer nozzles to see if they are blocked. Turn on one section at a time (while standing at the back of the boom - at sufficient distance not to get sprayed) and make sure all nozzles are spraying correctly.
- Display Auto Fill Control for sprayers fitted with an Apollo ECU. With the auto fill window displayed on the mobile device, you can set the 'target volume', monitor the 'actual volume' and 'volume remaining to target', as well as start and stop the fill operation, without having to return to the cabin.
- View the valve balancing wizard for sprayers fitted with an ASC-10 ECU. Currently you have to be able to see the screen to know if you need to increase / decrease the return flow for each section, which can be difficult for a large sprayer. This is much easier to do with the wizard displayed on a mobile device.
- Display the recipe calculator on an external device, to display quantities of chemicals required to be mixed while standing at the sprayer. This removes the need to return to the cabin if you want to check the values or change a recipe. With the recipe calculator running on your mobile device, you can remain at the mixing station while you make the adjustments.
- Perform sprayer flow meter calibration. With the wizard displayed on the mobile device, you can run through each step of the calibration (which is usually performed at the back of the machine) without having to return to the cabin.

Seeder:

- Perform seeder implement seed rate calibration. With the calibration window on the mobile device, you can perform the entire calibration, including entering weights, without needing to return to the cabin.
- Display the blocked head sensor setup on an air seeder. During the setup for the blocked head sensors, you need to connect the sensors in the order in which you want them to appear on the screen as you assign them to heads. Currently this either requires two people, or you have to return to the cabin each time you connect a

sensor. With the setup window displayed on the mobile device, this process can easily be performed by one person.

- Perform down force calibration on an air seeder. This requires recording and then entering the load that is applied by the press wheel, so you need to return to the cabin to do this step. With the wizard on the mobile device, the process can be performed without needing to return to the cabin.
- Setup and replace ECUs for a seeder implement. This requires ECUs to be disconnected / reconnected while pressing 'Next' on the screen.

YieldTrakk:

- Enter the true weight of grain from the scales on the grain cart when calibrating YieldTrakk. The operator in the combine can use XTEND to view the screen on the display in the grain cart so they can instantly see the weight as they unload.







NORAC:

- Perform testing of the initial installation of Norac and set the proper target height for each field via the display on a mobile device.

5.2.6. VDC setup

The VDC (Vehicle Display Controller) is an optional device that may be used to remotely perform a selection of display functions.

To set up VDC functionality:

1. Select **System**  / **Features**  / **Console**  .
2. Select **VDC SUPPORT** to enable the VDC functionality.
3. Select **System**  / **Features**  / **VDC**  to assign functions.

5.2. Setting features



Button 5 is always set as the Back button.

Select Button 1 - 4 to assign a function.







5.3. Setting up GPS

5.3.1. Receiver setup

Sets up GPS receiver capabilities.

1. Select **System**  / **GPS**  / **Receiver**  .

GPS Receiver Selection

<div style="background-color: #f0f0f0; padding: 5px; margin-bottom: 5px;">  GPS RECEIVER AGI-4 </div> <div style="background-color: #f0f0f0; padding: 5px; margin-bottom: 5px;">  FIRMWARE UPGRADE Click to Upgrade </div> <div style="background-color: #f0f0f0; padding: 5px; margin-bottom: 5px;">  USE IGNITION LINE <input checked="" type="checkbox"/> Enabled </div> <div style="background-color: #f0f0f0; padding: 5px; margin-bottom: 5px;">  KEEP ALIVE TIME (MINUTES) 30 </div> <div style="background-color: #f0f0f0; padding: 5px; margin-bottom: 5px;">  LOAD OAF FILE USB </div> <div style="background-color: #f0f0f0; padding: 5px;">  BAUD RATE 115200 </div>	<div style="background-color: #f0f0f0; padding: 5px;">  FIRMWARE UPGRADE BAUD RATE 460800 </div>
--	--

- **GPS receiver:** Select the GPS receiver type from the selection list. The display can accept GPS input from a third party GPS receiver provided the receiver can be configured to output the data in the required correct format. Please consult the GPS receiver manufacturer to find out if your receiver can be set up in the correct way.

The display requires the following input if **NMEA Source** is selected under **GPS RECEIVER**:

- GGA 0.2 seconds (5Hz)
- VTG 0.2 sec (5Hz)
- ZDA 15 seconds

RS-232 communications

- 115200 baud rate (preferred) 8 data bits, No Parity, 1 Stop bit (115200, 8N1)

- **Firmware upgrade:** Initiates a GPS receiver firmware upgrade via the package that comes bundled internally with the display software. The Firmware Upgrade button shows the version of the firmware that is currently in the GPS receiver and the version of the firmware to which it will be upgraded.
- **Use ignition line:** (AGI-4 and AGS-2) Separates the power supply to the GPS receiver from the vehicle ignition. This enables the GPS receiver to remain powered after the vehicle is turned off. The **Keep Alive Time** determines how long the receiver remains powered.
Note: This feature should only be used **if the vehicle wiring and harnessing is compatible.**
- **Keep alive time:** (AGI-4 and AGS-2) Keeps the GPS receiver active after the system has been shut down. This is useful to retain accurate positioning information (satellite convergence). For example: To keep the receiver on for 1 hour after the system is shut down, enter 60.
Note: This feature is only available if **Use Ignition Line** is set to **Enabled.**
- **Load OAF file:** Loads an Options Authorization File to the GPS receiver. This is normally done prior to receiver installation, but the file can be updated in the field via USB (if required).
- **Baud rate:** The data transmission rate for modems. GPS receiver baud rate can be changed from the default value. This setting should not normally be altered. If the setting does need to be changed, refer to the manual supplied with the modem.
- **Firmware upgrade baud rate:** The data transmission rate during firmware upgrade. This setting should not normally be altered unless the firmware upgrade fails at the default rate.
- **Reverse control:** When using GPS receivers that don't support auto steer (e.g. SGR-1), this option is used to switch the direction of travel

shown on the map if it is initially incorrect due to not having a compass. Select  in the bottom right of the operation screen to switch direction.

5.3.2. Correction setup

GPS correction sources are used to increase the accuracy of the GPS position.

1. Select **System**  / **GPS**  / **Correction**  .

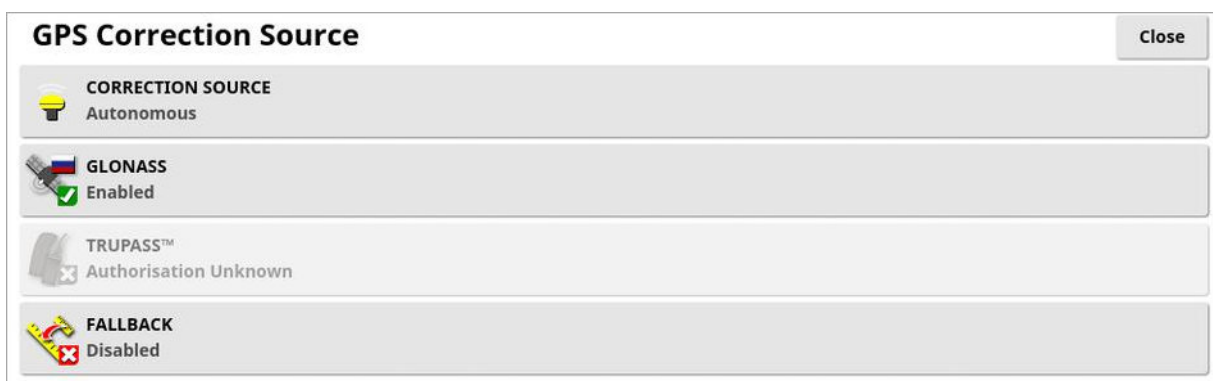

2. Select the required **CORRECTION SOURCE**.

Note: The available correction sources are defined below. The extra options that must be defined vary depending on the correction source selected, see [Correction source options, page 63](#).

Correction sources

Correction Source	Description
Autonomous	Let the receiver find any free available satellites. Will not use any correction. Precision: 2 - 5 m.
DGPS (External Modem)	Use an external modem to import DGPS corrections from a network provider. Precision: sub-meter.
DGPS (NTRIP)	Use a cellular delivered DGPS correction source from a network provider. Precision: sub-meter.

5.3. Setting up GPS

Correction Source	Description
EGNOS	Use the European Geostationary Navigation Overlay Service. Europe only. Precision: sub-meter.
MSAS	Use Multi-functional Satellite Augmentation System. East Asia only. Precision: sub-meter.
OmniSTAR G2	Use OmniSTAR G2 correction. Precision: 10 cm.
OmniSTAR HP	Use OmniSTAR HP correction. Precision: 10 cm.
OmniSTAR VBS	Use OmniSTAR Virtual Base Station (VBS) correction. Precision: sub-meter.
OmniSTAR XP	Use OmniSTAR XP correction. Precision: 10 cm.
RTK	Use Real Time Kinematic navigation. Precision: 2 cm.
RTK (External Modem)	Use external modem connected to GPS receiver for RTK corrections. Precision: 2 cm.
RTK (NTRIP)	Use a cellular delivered RTK correction source from a network provider. Precision: 2 cm.
TopNET Global D	AGI-4: Precision: < 10 cm
Topnet Live Realpoint	Use a cellular delivered RTK correction source. Precision: 1 cm.

Correction Source	Description
Topnet Live Starpoint	Uses Starpoint correction and is available in the following subscription types: Starpoint. Precision: < 40 cm Starpoint Pro. Precision: < 5 cm
WAAS	Use Wide Area Augmentation System. North America only. Precision: sub-meter.

Note: The source selected here will affect the functioning of guidance and auto steering. It is important to be aware of the needs of the GPS equipment. Refer to the manual supplied with the GPS equipment.

Note: Precision figures depend on many variables (number of satellites, distance from the correction source, ionospheric conditions, receiver, antenna) and cannot be guaranteed.

Correction source options

Note: The correction source options that must be defined vary depending on the correction source selected.

Option	Description
GLONASS	Allows the GPS receiver to use the Russian satellite navigation system GLONASS, in addition to GPS.
TRUPASS	Topcon's GPS drift compensation algorithm, used to provide better pass to pass performance. Available with the following correction sources: Autonomous, WAAS, EGNOS, MSAS and OmniSTAR VBS. Note: This option must be purchased separately.

5.3. Setting up GPS

Option	Description
NTRIP Source	<p>Shown when either RTK (NTRIP) or DGPS (NTRIP) is selected.</p> <p>The Receiver option uses the NTRIP client within the AGI receiver.</p> <p>Selecting Console enables the display NTRIP client and configures the AGI to use the display as an external modem for correction data. Note: The NTRIP client serial port can be selected on the serial ports setup page. See Setting up serial ports (X25/X35 only), page 69.</p>
Modem	<p>Allows the selection of the modem used for receiving corrections (Other, Managed).</p>
RTK Protocol	<p>Communication protocol for data transfer between the RTK base station and the rover (tractor). Must be set to same protocol as base station. Refer to base station setup information.</p>
Region	<p>The Region must be selected to determine the frequency used by OmniSTAR. The frequency for the region is set automatically.</p>
Fallback	<p>If the system is not receiving enough data to compute the vehicle's position with the required accuracy, auto steering cannot be engaged. The fallback feature allows the system to reduce the position accuracy requirement so that auto steering can be engaged. This is useful in situations where a high degree of position accuracy is not required.</p>

Option	Description
Skybridge	This is a mode that allows all RTK modes to fall back to PPP (Precise Point Positioning). It is used in the field to maintain sub-decimetre accuracy if RTK corrections are lost for any reason. This option is only available for use with the AGS-2 receiver. Note: It is recommended that Fallback is not enabled when using Skybridge to maintain higher accuracy.
Baud Rate	The data transmission rate for modems. Refer to documentation supplied with modem.
GGA Output	Some network providers require a GGA (position) to be sent to them to allow them to identify the location of the rover (tractor).

NTRIP setup options

If DGPS NTRIP is selected, a wizard launches to detect the attached modem, then the following screen is displayed.

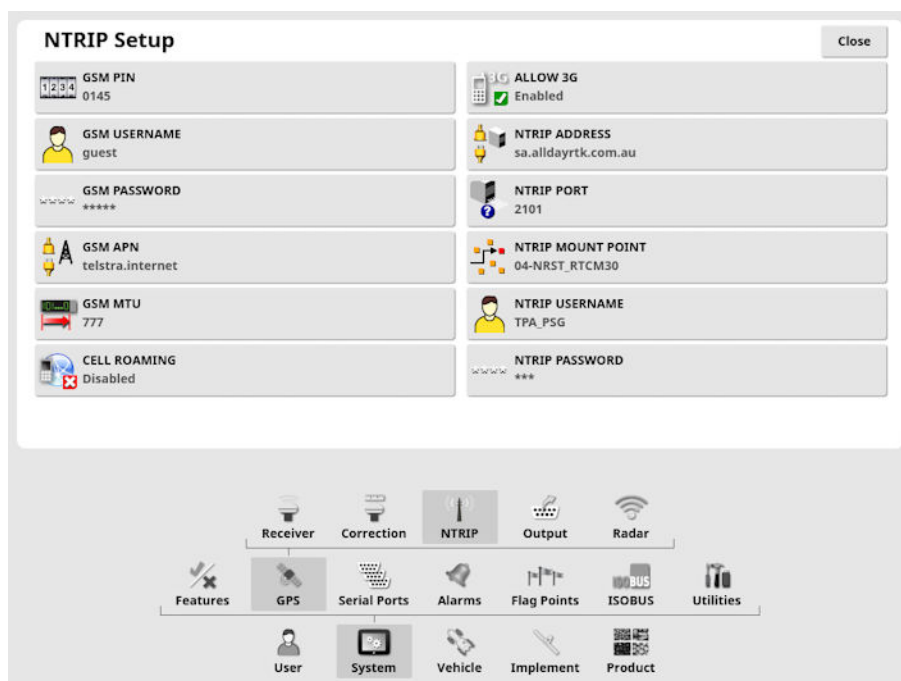

5.3. Setting up GPS

- **GSM APN:** The telecommunication provider's internet link.
- **GSM MTU** (Maximum Transmission Units): The largest protocol data unit that can be passed onwards.
- **Cell roaming:** This may be used to disable cell roaming to prevent accidental cross-border data charges (useful if working near the border of another country).
- **NTRIP Mount point:** The ID of the base station (either real or virtual).

The GSM and CELL ROAMING settings can be obtained from your cellular network provider. The remaining settings are provided by your NTRIP service provider.

RTK setup options

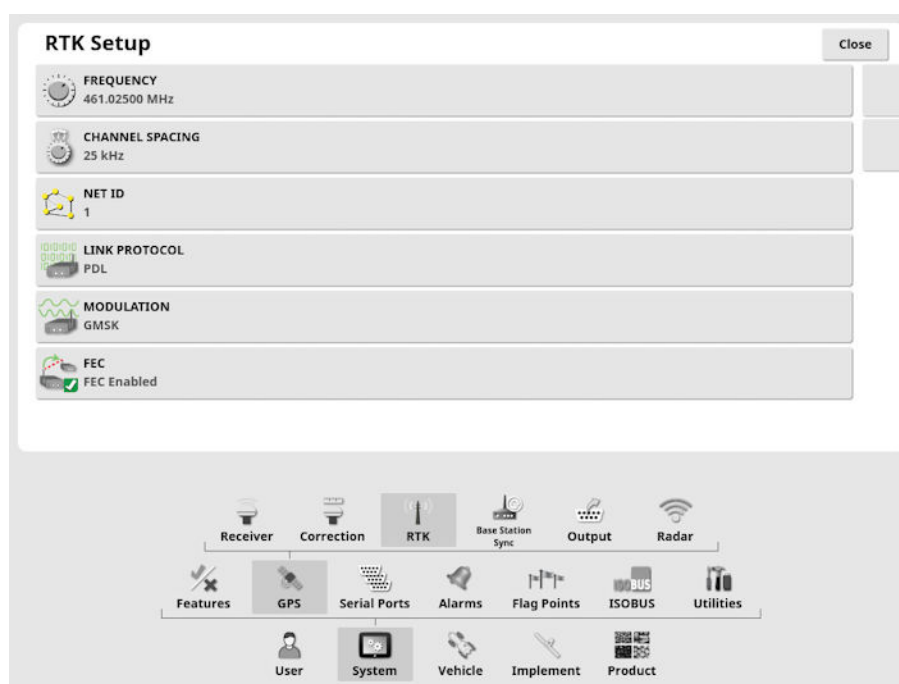

If RTK is selected, a wizard launches to detect the attached modem, then the following screen is displayed.



- **Frequency:** The frequency used.
- **Channel spacing:** The frequency difference between adjacent allocations in a frequency plan.
- **Net ID:** The setting for scrambling (1-255 = on, 0 = off).
- **Link protocol:** Radio data transmission protocol.
- **Modulation:** The type of modulation used.

- **FEC** (Forward Error Correction): A technique used for controlling errors in data transmission over unreliable or noisy communication channels.

Note: If RTK is selected and an AGI-3 or AGI-4 is connected, the base station settings can be automatically synced with the entered receiver settings. Select **System / GPS / Base Station Sync** and follow the instructions displayed on the wizard.

-  **Load settings from profile:** Load the RTK base station settings from a previously saved profile.
-  **Save settings to profile:** Save the current RTK base station settings to a named profile. Creates a new profile or overwrites an existing profile.

Note: Modem settings are unique, so a profile created on one receiver cannot be loaded onto another receiver if the modem type is different. If you have multiple receivers that are going to be used with one console, we suggest naming them with the specific receiver in the profile name to make it easily identifiable.

Profiles can be renamed or deleted in the Inventory Manager, **RTK base stations** category. They can also be imported from other displays or exported for use on other Topcon displays.

5.3.3. Output setup (X25/X35 only)

GPS output refers to the display's ability to export various data strings in NMEA 0183 format. The most common of these is the GGA (Position) message and the VTG (Velocity and Heading) message.

This may be useful to connect to third party devices for position and speed outputs.

To set up the GPS output:

1. Select **System**  / **GPS**  / **Output**  .

5.3. Setting up GPS

GPS Output Settings Close

GPS OUTPUT Disabled	Sentence	State
BAUD RATE 19200	GGA ×	Disabled
MAXIMUM RATE 5 Hz	GSV ×	Disabled
OUTPUT PRECISION High Precision	VTG ×	Disabled
VTG LEGACY MODE Enabled	GSA ×	Disabled
	ZDA ×	Disabled
	RMC ×	Disabled

- **VTG legacy mode:** Supports VTG data output for NMEA standards below V4.00. Outputs VTG strings compatible with NMEA V3 and below.

Refer to documentation provided with third party device for more information.

Note: Devices using GPS and plugged into the display may need information from the display. The information is contained in sentences based on NMEA.

5.3.4. Radar setup (X25/X35 only)

The display can provide radar output to external devices. This may be useful to connect to a third party device to provide a ground speed signal.

To set up radar output:

1. Select **System** / **GPS** / **Radar** .

Radar Output Setup Close

RADAR OUTPUT Disabled
CALIBRATION FACTOR 36.625 Hz/km/h

- **Calibration Factor:** Refer to the third party device for this figure if the radar speed signal is not accurate.

5.4. Setting up serial ports (X25/X35 only)

Sets the display serial port assigned to a particular function.

1. Select **System**  / **Serial Ports**  .

Serial Ports Setup		Close
	GPS RECEIVER COM 1	
	GPS OUTPUT COM 2	
	XLINKS COM 3	
	LH5000 RATE SENSOR COM Not Assigned	
	NTRIP CLIENT COM Not Assigned	

2. Select the required function and from the selection list, select the display serial port to which the device is connected.

For example: SGR-1, AGI-4 or AGS-2 GPS Receiver is connected to serial port 1 with all Topcon harnesses.

NMEA GPS Output is generally on serial port 2 if in use. Xlinks is on serial port 3 if in use, or on serial port 2 if NMEA GPS out is not in use.

5.5. Setting up alarms

If no implements have been set up in the system, only General alarms are available to set up. Implement specific alarms are available once an implement has been defined. Refer to the Spreader / Sprayer / Seeder Operator manuals for more information.

To set up general alarms:

1. Select **System**  / **Alarms**  / **General** .

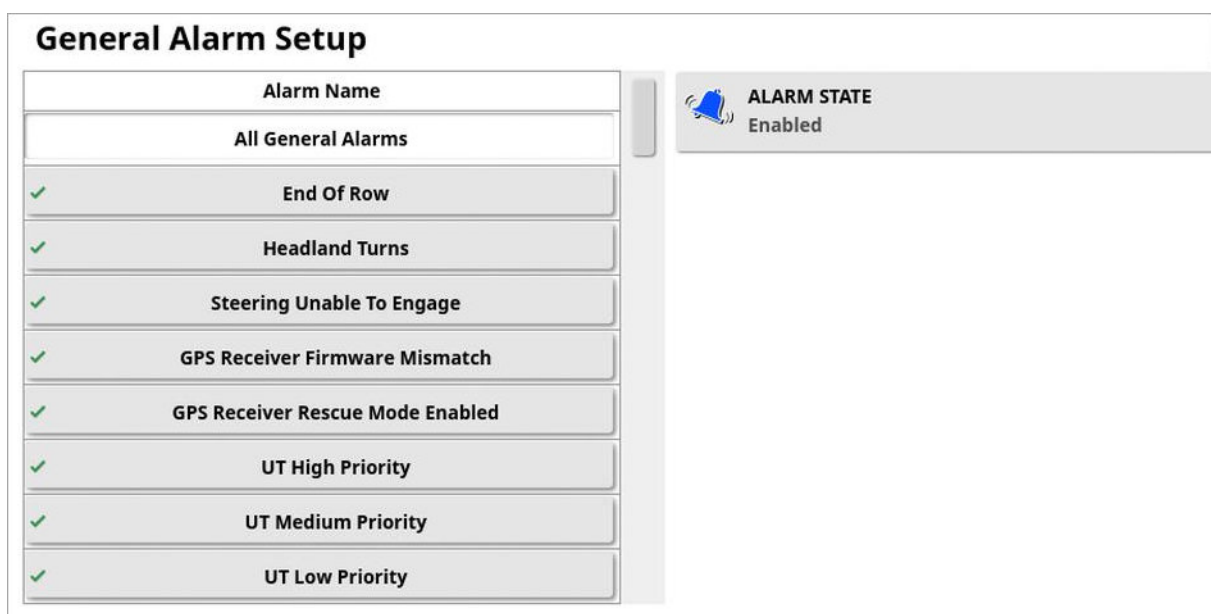

The list of general alarms is displayed. All general alarms may be enabled or disabled by selecting **All General Alarms**.

Alternatively, each general alarm may be enabled or disabled independently.

Note that for safety reasons, the **Steering Engage/Disengage** audible alarm may not be disabled.

Alarms that require extra information are listed below.

End of row

This alarm sounds and displays when the vehicle is approaching the boundary and the operator should slow down to prepare for manual control.

- **First Distance:** Distance from the boundary at which the alarm will first trigger. Distance is measured from the tractor to the boundary along the wayline (guideline).
- **Second Distance:** Distance from the boundary at which the second alarm will trigger, warning the operator to immediately take control of the vehicle.
- **Look Ahead Distance:** Sets how many meters in front of the vehicle that the system looks to respond with actions.

Headland turns

This alarm sounds and displays when the vehicle is approaching the headland for an autosteer headland turn and allows the turn to be adjusted or cancelled, if required.

Note: The headland alarm can be displayed manually if required. See [Configure headland turns, page 206](#).

- **Distance to Headland:** Distance from the headland at which the headland alarm will display.
- **Turn Options:** Sets whether the edit headland turns options are displayed on the headland alarm by default.

ISOBUS task controller

This alarm displays if there are issues with the ISOBUS task controller.

- **Trigger level:** Determines what priority message must be generated in order to trigger the alarm to occur.
- **Filter level:** Once the alarm is shown, the text includes all messages that are at least as high in priority as the level selected here.

For example; If **Trigger** is set to **Warning** and **Filter** is set to **Info**, an alarm is not generated unless a warning or higher event is seen. However, when the alarm is shown, every event down to info level related to that ECU is shown.

Flag point nearby

- **Trigger when flag point within:** Distance from the flag point at which the flag point alarm will display.

Registration expiring

This alarm displays when an optional licensed feature is going to expire in the entered number of days. A value between 5 and 366 days may be entered.

5.5.1. Alarm window description

To acknowledge an alarm, press the center of the alarm window.



The alarm window may be dragged down to display additional details about the alarm if **Drag down for details** is displayed at the top of the alarm window.

If more than one alarm is active, you can swipe up to flip through the active alarms.

The speaker icon may be used to mute the alarm.

The spanner icon displays the appropriate alarm setup page to configure that alarm (or disable it if it's not relevant to your current setup). There are a few exceptions to this behavior:

- The GPS Receiver Firmware Mismatch spanner displays the setup screen to upgrade your GPS receiver firmware.
- The ASC-10 ECU Firmware Mismatch spanner displays the screen to upgrade your ASC-10 firmware.
- The No GPS Time alarm displays the time/date setup screen to enter the correct local time.

5.5.2. Alarms list

This is a list of the alarms on the display and their descriptions.

Alarm	Description
Active field far away	The active field is more than 8 km (5 miles) away. Ensure the correct field is loaded or create a new field.
Apollo hardware warnings	Provides information about Apollo hardware problems.
Applying guideline nudge offset	Notification that an existing nudge offset is being applied.
ASC10 ECU firmware mismatch	Select the spanner to display the screen required to update the applicable firmware.
Base station location mismatch	The location of the base station used to create a guidance pattern doesn't match the current base station position.
C24 modem activation failed	Triggered if the C24 modem activation process fails for any reason.
C24 modem activation in progress	A C24 modem must be activated the first time it is used. This involves an exchange of data with the carrier. The operator has to initiate this process. To provide feedback to the operator that the process has been initiated, this message is displayed.
COM port fail	Triggered if the specified COM port cannot be opened.
Conveyor speed high	Triggered when the conveyor speed high alarm indicates that the speed signal input has exceeded the alarm point setting.

5.5. Setting up alarms

Alarm	Description
Conveyor stopped	Triggered when the conveyor belt has stopped, the tank and master switch is on, ground speed indicates that there is movement and that the belt should be moving.
Conveyor stuck valve	If the tank is just turned off, the stuck valve alarm is inhibited for a period of time to give the belt time to stop moving, after which if it hasn't stopped, the alarm will be triggered.
End of row	Triggered when the vehicle is approaching the boundary and the operator should soon take control.
Exclusion map distant	Triggered when the exclusion map is too far from the current GPS position. The exclusion map is unloaded automatically.
Fallback	Triggered when the selected GPS correction source is not available and the system must use a less accurate correction source temporarily.
Field unloaded	Triggered when a field has been exited due to current distance from the selected field.
Flow sensor failure	Triggered whenever the master switch is turned on, there is movement over the ground, at least one section is turned on, and there are no flow sensor pulses being received.
Firmware version mismatch / outdated	Select the spanner to display the screen required to update the applicable firmware.

Alarm	Description
GPS drift correction	Triggered on startup as an informational reminder that the GPS drift correct has been applied. Since GPS drift varies with time this is a reminder that GPS drift compensation may need to be recalculated.
GPS lost	Triggered when the GPS signal is lost but the receiver is still connected.
GPS receiver firmware mismatch	Select the spanner to display the screen required to update the applicable firmware.
Headland turns	Triggered when the vehicle is approaching the headland for an autosteer headland turn.
Incorrect gear ratio	There is an incorrect ratio between the channel shaft and motor encoders.
Incorrect rate	The implement is in auto mode and the target application rate is not achieved.
Invalid vehicle profile	The selected vehicle profile contains invalid parameters. Please create a new vehicle profile or contact your dealer for assistance.
Invalid / obsolete profile loaded	Triggered when an old implement or vehicle profile is active on the system. This can occur if upgrading from a very old version of the software to the latest version.
Liquid pressure high	Triggered if the tank pressure is greater than the maximum specified tank pressure.
Liquid pressure low	Triggered if the tank pressure is less than the minimum specified tank pressure.
Low resources	Triggered when the system resources (memory or space on the file system) are more than 90% full.

5.5. Setting up alarms

Alarm	Description
Master switch off	Triggered when the operator is driving over an area that is untreated on the coverage map with the master switch off. (To prevent operators from forgetting to engage the master switch at the start of a run.)
Max guideline length exceeded	Triggered when the length of the recorded line exceeds the maximum number of points (typically several kilometres, but will vary based on how complex the curve is).
No comms	Triggered if the display is unable to communicate with the implement ECU.
No comms with VDC	No communication with VDC. Occurs if VDC is enabled, but there is no physical VDC device or it hasn't been connected properly.
No GPS	Triggered if the GPS connection is lost.
No GPS time	Triggered if the GPS receiver is not configured to send time messages (ZDA NMEA messages).
No ground speed	Triggered if the auto steering is on and there is no ground speed present.
No SIM detected	Triggered if a modem is detected but it has no SIM card.
Not flowing	Triggered if no liquid/NH3 flow is detected by the flow confirmation sensor with the master switch and tank on.
NTRIP failure	GPS correction source failure.

Alarm	Description
Parameters mismatch	Vehicle geometry parameters do not match the geometry configuration in the steering system. Re-select the vehicle on the Setup screen or ensure the vehicle geometry in the vehicle geometry screen is correct.
Path too far away	Triggered if the active guideline (AB line, curve or pivot) is too far away from the current GPS position.
Prescription map distant	Triggered if the active VRC map is too far away from the current GPS position.
Prescription map / guidance shapefile load fail	Triggered if the file being loaded is invalid or corrupted.
Pressure high	The high pressure alarm indicates that the pressure signal input has exceeded the alarm point setting. If correctly set, this usually indicates a blockage, booms off when they should be on, or sprayer speed too high.
Pressure low	The most common cause is an empty tank. With minimum flows set for nozzles, flow meter and pressure, this alarm will only display with pump or plumbing failures or an empty tank.
Project line too far	Triggered if the active set of project lines is too far away from the current GPS position.
Pump speed low	Triggered if pump speed sensing is enabled and the pump speed drops below the minimum RPM threshold setting for the alarm.

5.5. Setting up alarms

Alarm	Description
Pump speed high	Triggered if pump speed sensing is enabled and the pump speed exceeds the maximum RPM threshold setting for the alarm.
Receiver disconnected	The GPS receiver is not responding. Check the receiver connections.
Registration expiring	Registered feature expires within the next <days until expiry> days. Please contact your dealer to renew registration.
Requested rate is zero	Triggered when auto rate control is enabled, tank is on, master switch is on and the requested rate is zero. If there is a switchbox, check that at least one switch is on.
Resources exhausted	Triggered if the system resources (memory or space on the file system) are more than 97% full.
Reverse station	Informational alarm triggered when the operator's seat is rotated by 180 degrees (only applicable for tractors with dual driving stations).
RTK base sync failure	Triggered if the display fails to synchronise with the RTK base station.
Shaft is moving tank off	Triggered if the shaft is moving but the tank or master is off.
Shaft stopped	Triggered if the tank is active but the shaft has stopped moving. 'tank active' means: tank on, master switch on, at least one section on, moving.

Alarm	Description
Spinner not active	Triggered if the main periodic processing timer has expired, the tank is on, master switch on and there are no active sections.
Steering disengage (visual)	Triggered when the steering has been disengaged. This may be due to losing satellites, losing the guideline or manually turning the steering wheel.
Steering engage (visual)	The Steering Engage/Disengage alarms cannot be silenced for safety reasons, however, the visual component of the alarm can be suppressed if desired.
Steering profile mismatch	The parameters in the selected vehicle profile do not match the vehicle configuration in the steering subsystem. Select the correct vehicle profile for this vehicle.
Steering restart needed	Triggered if the steering subsystem needs to be power cycled. Occurs for some types of steering subsystem after calibration.
Steering unable to engage	The steering status popup which appears when steering cannot be engaged as requested can be suppressed. If the engage button is pressed this auto clearing alarm is shown to indicate the requested could not be completed.
Tank active, no rate	Triggered if master switch is on, tank is enabled, tank is active, tank is not in manual, vehicle is moving and the set rate is zero.
Tank empty	This indicates that the calculated volume has reached zero. If there are still contents in the tank, the system will still operate showing the tank volume as a negative figure.
Tank low	This gives a warning that the tank is running low.

5.5. Setting up alarms

Alarm	Description
Tank off	Triggered if the tank is off while the master switch is on and the vehicle is moving with at least one section turned on.
Tramline accuracy degraded	Triggered during spraying if the system detects that the smoothing factor specified earlier during seeding differs from the one currently specified during spraying.
Tramline implement width mismatch	Triggered during spraying if the system detects that the sprayer implement width specified earlier during seeding differs from the one currently specified during spraying.
Tramline pass	Triggered during seeding if the system detects that the seeder wheels are following where the sprayer wheels will later be.
Unregistered feature	Triggered if there is an enabled feature that is no longer registered (registration has expired). This is to inform the operator that the feature has been disabled.
UT high priority	Universal Terminal high priority alert. There is an urgent issue the user should address on the UT immediately.
UT medium priority	Universal Terminal medium priority alert. There is an important issue the user should address on the UT when possible.
UT low priority	Universal Terminal low priority alert. There is an issue the user should address on the UT when possible.
VDC connection	Triggered when the connection to the VDC is lost or the VDC is missing.
Wireless connection	Triggered when the wireless network connection is no longer in range.

5.6. Setting up flag points

Flag points show obstacles or other land features for a field on the Operation screen. Flag points are set during operation by driving to the flag point location. See [Setting flag points, page 165](#).

Flag point symbols and names can be defined in the Setup screen.

To change flag point preset symbols and names:

1. Select **System**  / **Flag Points** .

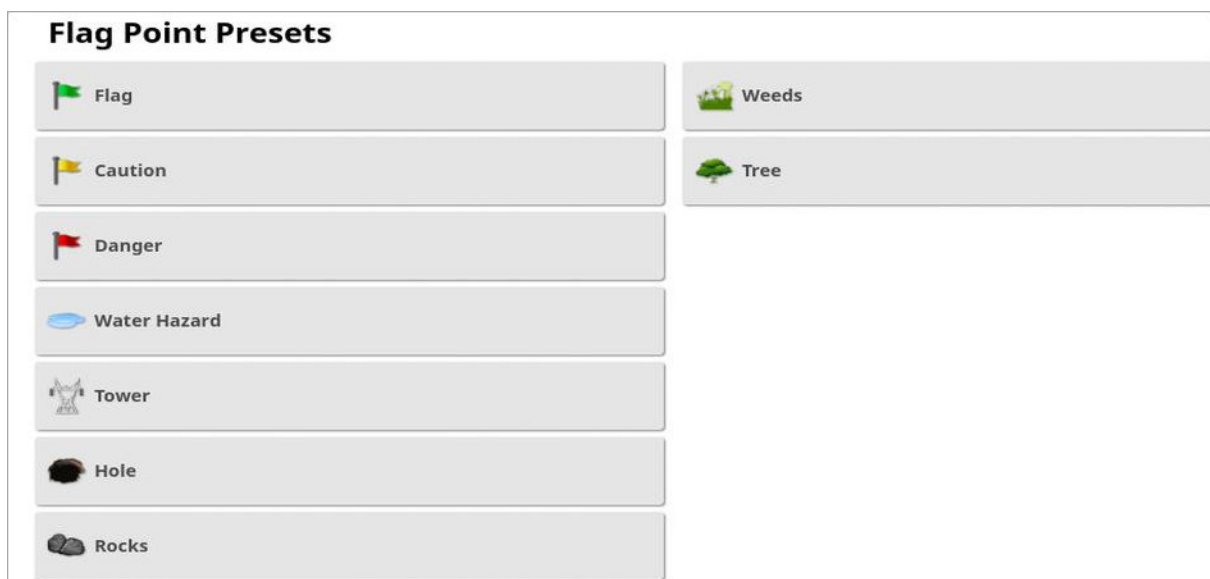

2. Select the flag having its symbol or name changed.
3. Select the new symbol or select **FLAG POINT NAME** and type in the new name for the flag, then confirm.

Note that flags can be changed but new preset flags cannot be created.

5.7. Setting up ISOBUS / universal terminal

1. Select **System**  / **ISOBUS** .

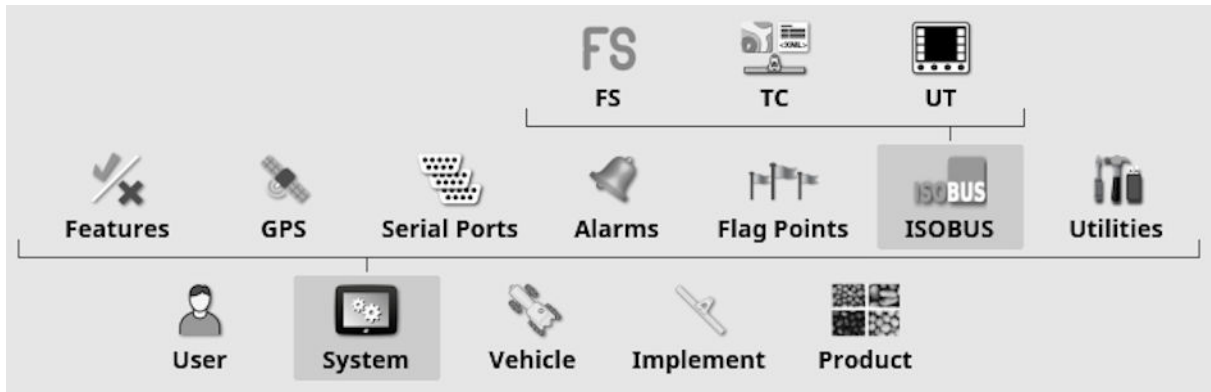

5.7.1. File server setup

To set up the file server:

1. Select **System**  / **ISOBUS**  / **FS** .



- **FS version**: Controls which version of the file server specification the UT server supports. It is recommended to leave it at latest unless problems are encountered in the UT
- **FS number**: The instance number of the file server. This enables clients to know which server(console) to connect to. Clients without a UI for this should default to lowest number.
- **Clear internal files**: The file server exposes two 'volumes'. One is USB, the other is an internal one inside the console that can only be read / written to by ISOBUS clients themselves. This option clears those files.

5.7.2. Task controller setup

To set up the task controller:

1. Select **System**  / **ISOBUS**  / **TC**  .

Task Controller Setup Close

 **TC VERSION**
3

 **TC NUMBER**
1

 **CLEAR POOL CACHE**
Click to clear ECU cache

 **MANUAL SECTION CONTROL MODE**
Controlled by Console

- **TC Version:** Sets the task controller version. This should be left at the highest version, unless TC issues are encountered.
- **TC Number:** Sets the task controller instance number for the display. If there are multiple TCs on the bus, use this setting to assign a unique number to this TC to avoid conflicts. The TC with number 1 will be the default TC.
- **Clear pool cache:** Clears the contents of the TC pool cache. Should only be used if a TC error is displayed.
- **Manual section control mode:** Sets how section control will work in manual mode (ASC off):
 - **Controlled by console:** The display virtual section switchbox can be used to turn sections on and off.
 - **Controlled by ECU:** When ASC is turned off, sections will not be controlled by Horizon and will only be controlled by the ECU, either through its UT user interface or a physical switch connected to the ECU. Use this setting if you do not want to operate sections with the virtual switchbox when ASC is off.

5.7.3. Universal terminal setup

1. Select **System**  / **ISOBUS**  / **UT**  .

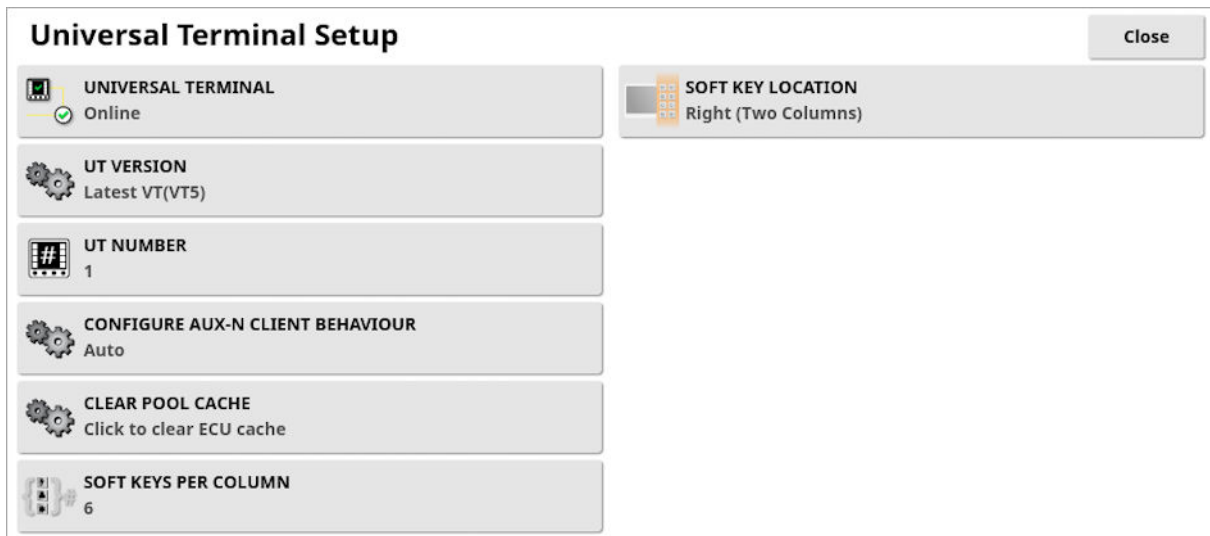

- **Universal terminal:** Controls whether the UT server is actively receiving connections from other devices.
This may be useful if there are multiple UTs on the bus and multiple UTs claim to be the primary UT (in which case the UT will go offline automatically and require the **UT Number** to be changed before it will go online again), or to temporarily deactivate the UT on the display.
- **UT version:** Controls which version of the ISO-11783-6 UT specification the UT server supports. It is recommended to leave it at **Latest** unless problems are encountered in the UT.
- **UT number:** Sets the UT number for the display. If there are multiple UTs on the bus, use this setting to assign a unique number to this UT to avoid conflicts. The UT with number 1 will be the default UT. If the UT client doesn't appear on the correct UT you may need to reconfigure its UT number appropriately. If there is a conflict, the following message will appear:
'The UT Number of this UT conflicts with another UT on the bus, and this UT has been disabled. Please make sure that this UT has a unique UT Number.'
- **Configure Aux-N client behaviour:** Enable/disable Aux inputs on this console. This setting is only relevant if you have more than one UT connected to the system at the same time (for example an X display and the tractor's UT). If **Auto** is selected then AUX inputs will be

enabled if **Universal Terminal** is set to **online** and the **UT number** is set to **1**.

- **Clear pool cache:** Clears the contents of the UT pool cache. Should only be used if a UT error is displayed.
- **Soft keys per column:** Sets the number of available softkeys on the UT interface on the Operation screen.
- **Soft key location:** Sets the location of the softkeys on the UT interface and the number of columns (1 or 2).

See [Using universal terminal \(ISOBUS\), page 237](#).

5.7.4. Auxiliary control setup

This option is available if **Universal Terminal** is enabled under **System / Features / Console**.

The AUX controls allow for external ISO compatible devices and the display to provide a set of functions that can be assigned to inputs on ISO compatible joysticks or other input devices.

To assign AUX controls:







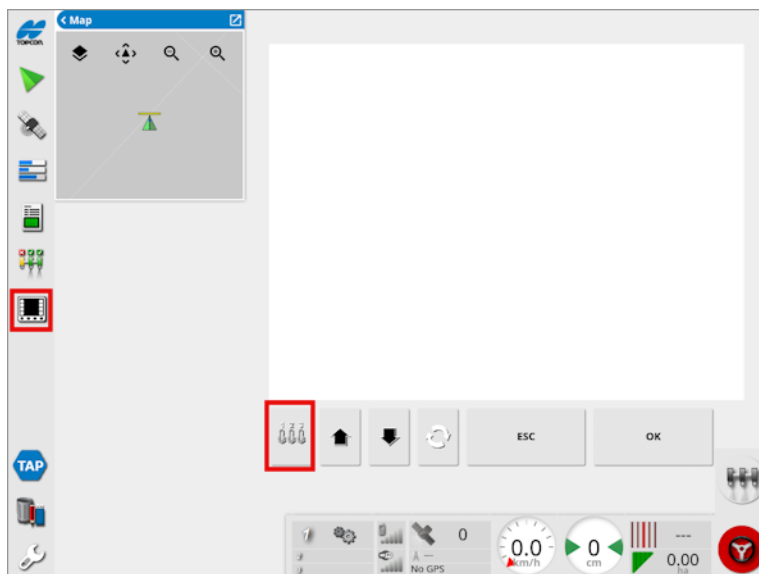

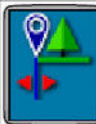

1. Select **Universal Terminal**  from the Navigation bar to open the mini-view.



Note: The icon/s displayed for the universal terminal vary depending on the attached ISOBUS compatible equipment. There may be more than one icon displayed. It does not matter which icon is selected.

5.7. Setting up ISOBUS / universal terminal

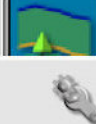

2. Expand the mini-view by selecting the arrow in the top right, or by swiping left to right across the mini-view.
3. Select the auxiliary control setup button  to display the functions that can be assigned to an input.



AUX-N Setup			
Device	Function	Name	Assignment
		Field: Boundary Recording Offset	
		Field: Clear Field Boundaries	
		Field: Complete Field Boundary	
		Field: Configure Headland	

Note: If more than one device is providing functions, the functions that are displayed can be filtered by selecting the filter by device button .

4. Scroll down the list to select the function to be assigned to an input and select the associated assignment button . The Change Assignment screen displays.

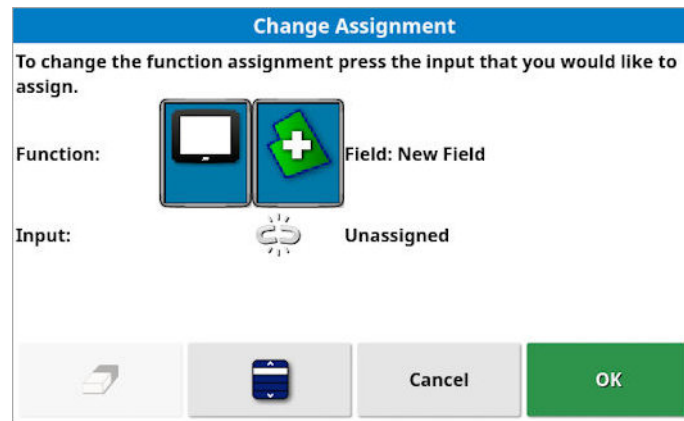

5. To assign the function, press the input button on the device (for example, external joystick) that will be used to perform the function, or press the manual assignment button  to select the input from a list.
6. To un-assign a function, open the Change Assignment screen and select the clear assignment button .

Once all the desired functions have been assigned and the AUX-N Setup screen has been closed, the assigned functions can be activated by pressing the assigned inputs. Please be aware that some functions will require the device or display to be in a ready state before the function can be activated.

F button aux assignment

The F button aux assignment adds up to three shortcut buttons for selected functions onto the operation screen, above the master switch.

5.7. Setting up ISOBUS / universal terminal

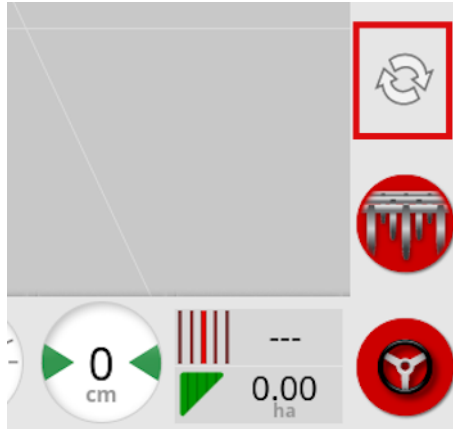

1. To assign these buttons, follow the procedure above to step 5 and select .
2. Select the F button from the **Select Input** list and press ok, then confirm.

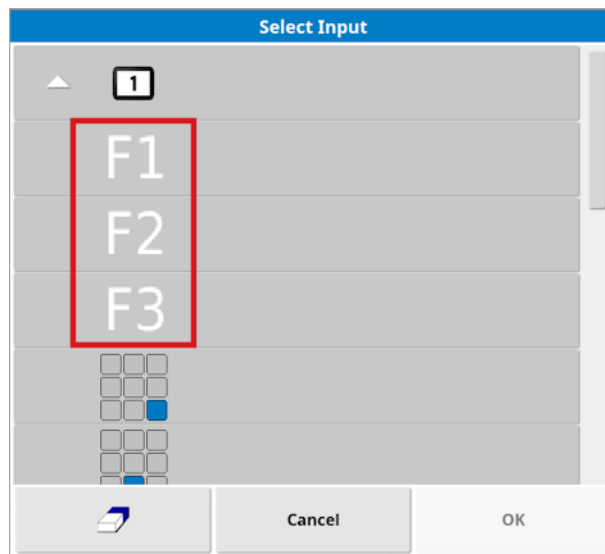

5.8. Setting up utilities

1. Select **System**  / **Utilities**  .

5.8.1. Display software upgrade (X25/X35)

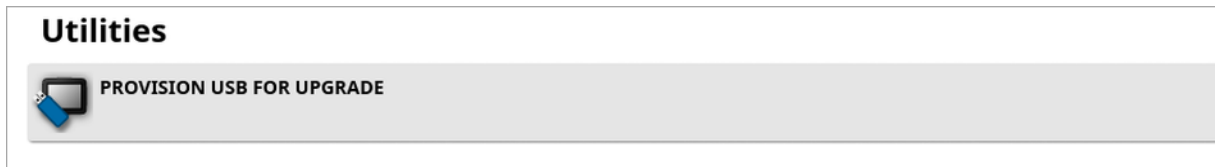

This option is used if the display software is being upgraded via a USB. Insert the USB and select this option to run a script that enables the USB to perform a software upgrade. A restart message is displayed to perform the upgrade immediately, or it can be performed the next time the USB is plugged into a display and the display is turned on. See [Firmware / software update instructions, page 22](#).

5.8.2. Display software upgrade (XD/XD+)

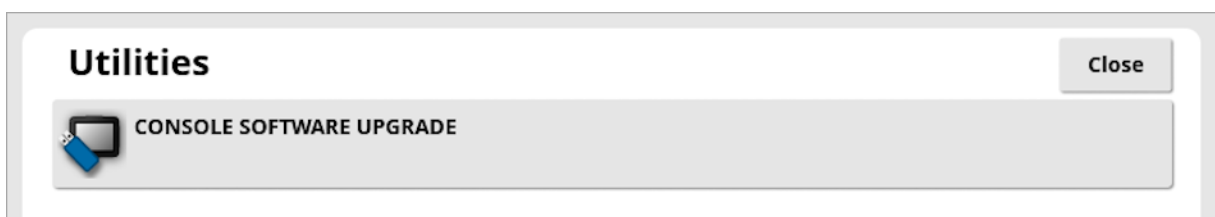

1. To upgrade the software, copy the installation files to the root directory of a USB drive and insert it into a running display.
2. Select **Console software upgrade**. The display will restart and begin the installation. See [Firmware / software update instructions, page 22](#).

5.9. Setting up Wi-Fi

A wireless connection is required for use with TAP (see [Using Topcon Agriculture Platform \(TAP\), page 3](#)), XTEND (see [XTEND setup, page 53](#)) and the remote support feature (see [Setting up remote support, page 40](#)).

5.9.1. Ethernet radio modem (CL-55)

1. Plug the CL-55 into the Ethernet port on the rear of the display.

2. Select **System**  / **Wi-Fi** .



Note: Once the CL-55 is connected, the internet modem (3G or LTE) is always enabled, so TAP and remote support can be used.

- **Wireless hotspot:** Create a wireless hotspot for phones and tablets to connect to. When hotspot settings are changed, the changes are not applied until you leave the setup screen. **Note:** Once this is set up, your mobile device can connect to the display to use XTEND.
- **SSID:** Enter the display name that will be displayed on wireless devices to identify the hotspot.
- **Key:** Enter the password that must be entered into the wireless device (mobile or tablet) when connecting to the hotspot. **Note:** This is mandatory for the hotspot to work. The key length must be between 8 and 63 ASCII characters.

5.9.2. USB Wi-Fi

1. Plug the USB Wi-Fi device (CL-10 or other dongle) into the USB port on the display.

2. Select **System** / **USB Wi-Fi** .

USB Wi-Fi
Close



CL10 WI-FI

Enabled



CONNECTION TYPE

Hotspot



SSID

Horizon_A8D3C800B352



ENCRYPTION

WPA2



KEY

751f1e2a



CHANNEL

Channel 6

Note: Once the USB dongle is connected, the internet modem (3G [if using a CL-10] or LTE) is always enabled, so TAP and remote support can be used.

- **CL10 Wi-Fi:** (Only shown if using a CL-10.) Enable to connect the display to a wireless hotspot (**Client**) or create a wireless hotspot (**Hotspot**). If this is disabled, 3G or LTE internet connectivity is still available.
- **Connection type:**
 - **Client:** Connect to a wireless hotspot (a phone or router setup as a hotspot). Enabling this option displays a wizard, which displays nearby Wi-Fi devices and requests a password to connect (if configured).
 - **Hotspot:** Create a wireless hotspot for phones and tablets to connect to. When hotspot settings are changed, the changes are not applied until you leave the setup screen.

Note: To use XTEND, you can select **Client** and connect to your mobile device's network, or select **Hotspot** and connect your mobile device to the display.

- **SSID:** Enter the display name that will be displayed on wireless devices to identify the hotspot.

- **Encryption:** Different levels of encryption are provided for the wireless connection. This may be necessary to prevent access to the display via the Wi-Fi connection or it can be switched off (open) if this is not a concern. If using encryption, either WPA or WPA2 is recommended, as these are widely supported by connecting devices and offer good security (compared to WEP).
- **Key:** Enter the password that must be entered into the wireless device (mobile or tablet) when connecting to hotspot if encryption is in use.

The key length for WPA security must be between 8 and 63 ASCII characters.

The key length for WEP security must be 5 or 13 ASCII characters (or 10 or 26 hexadecimal digits for 64 bit / 128 bit security respectively).

- **Channel:** Select a channel from 1 to 7 for the wireless hotspot for 2.4 GHz.

Note: If the CL-10 connects to the incorrect internet provider, select **System Information**, (see [Viewing system information, page 127](#)), maximise the screen, scroll down to the CL10 information and select the edit button next to **Network Operator**. Select the required provider from the list.

Wi-Fi behavior:

- Wi-Fi signal strength is shown on the dashboard.
- Stores the last five access points and keys to simplify reconnecting to frequently used devices.
- Wi-Fi logo in dashboard panel will flash when reconnecting to access point if connection is lost (when access point becomes available again).

Supported USB Wi-Fi devices:

- CL-10
- EDIMAX AC 600.

Note: Installing the EDIMAX onto another device and operating it at 5 GHz may violate the allowed frequency spectrum for the region. This device should only be used in conjunction with the supplied Topcon display.

- TP-Link TL-WN821N (V4) (300Mbps Wireless N USB adaptor)
- Netgear WNA1000M G54/N150 WiFi USB Micro adaptor
- Netgear WNA1000Mv2 N150 WiFi USB Micro adaptor
- Netis WF2120
- D-Link DWA-131 H/W Ver.:B1 F/W Ver.:2.01
- D-Link DWA-131 H/W Ver.:E1

Chapter 6 – Vehicle Setup

This chapter explains how to set up and access profile information about the vehicle on which the display is mounted. If the display is to be used on more than one vehicle then more than one vehicle profile must be set.

The **Vehicle** menu option provides the following menu items:

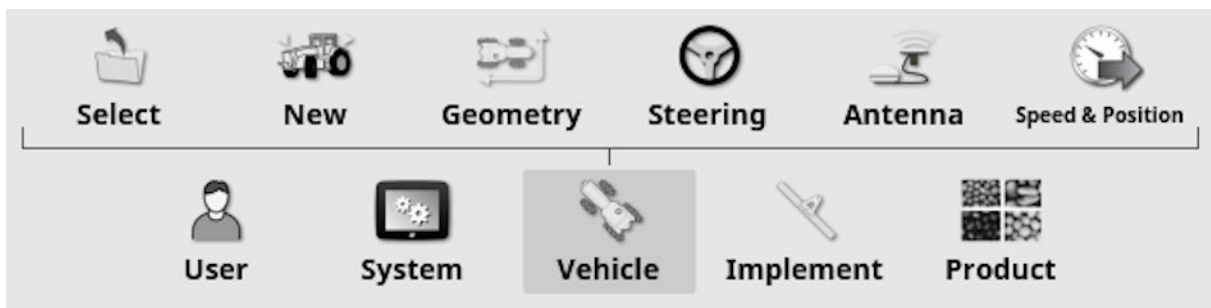

- **Select:** Select a vehicle from the previously created profiles. See [page 95](#).
- **New:** Create a new vehicle profile. See [page 96](#).
Note that **Select** and **New** are the only options available on this menu if no vehicles have been setup.
- **Geometry:** Sets the vehicle measurements so that guidance can work accurately. See [page 99](#).
- **Steering:** Controls how the vehicle will respond to guidance. See [page 101](#).
- **Antenna:** Sets whether the GPS receiver has an internal or external antenna. See [page 103](#).
- **Speed & Position:** See [Setting up GPS speed emulation, page 104](#).



6.1. Selecting a vehicle

Selects a vehicle from a previously defined list of vehicle profiles. This is blank when the display is first used.

To select a vehicle:

1. Select **Vehicle**  / **Select**  .

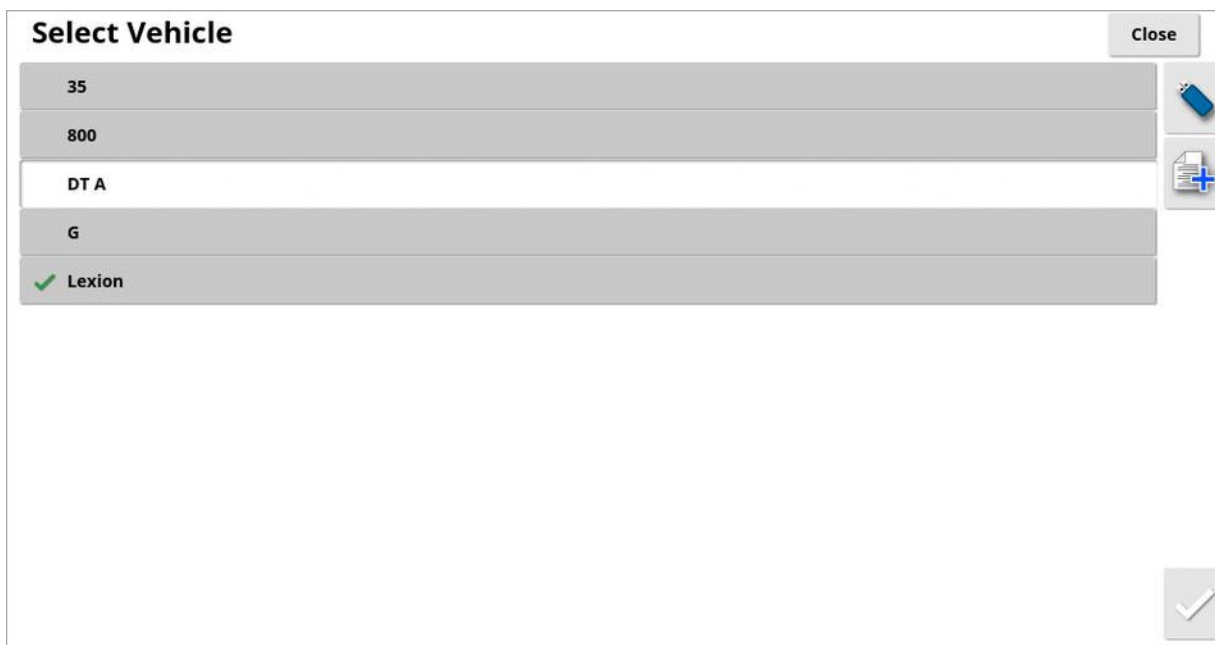

2. Highlight the required vehicle and confirm, or:



Select to import a vehicle profile from a USB.



Select to create a copy of the highlighted vehicle. This profile may then be edited.

Note: If the Vehicle Profile Mismatch alarm displays, selecting the vehicle with a tick next to it, then pressing the tick button on the right, sends the vehicle profile to the GPS receiver and resolves the alarm.

6.2. Creating a new vehicle

Creates a new vehicle profile for the vehicle on which the display is mounted.

To create a new vehicle profile:

1. Select **Vehicle**  / **New**  .

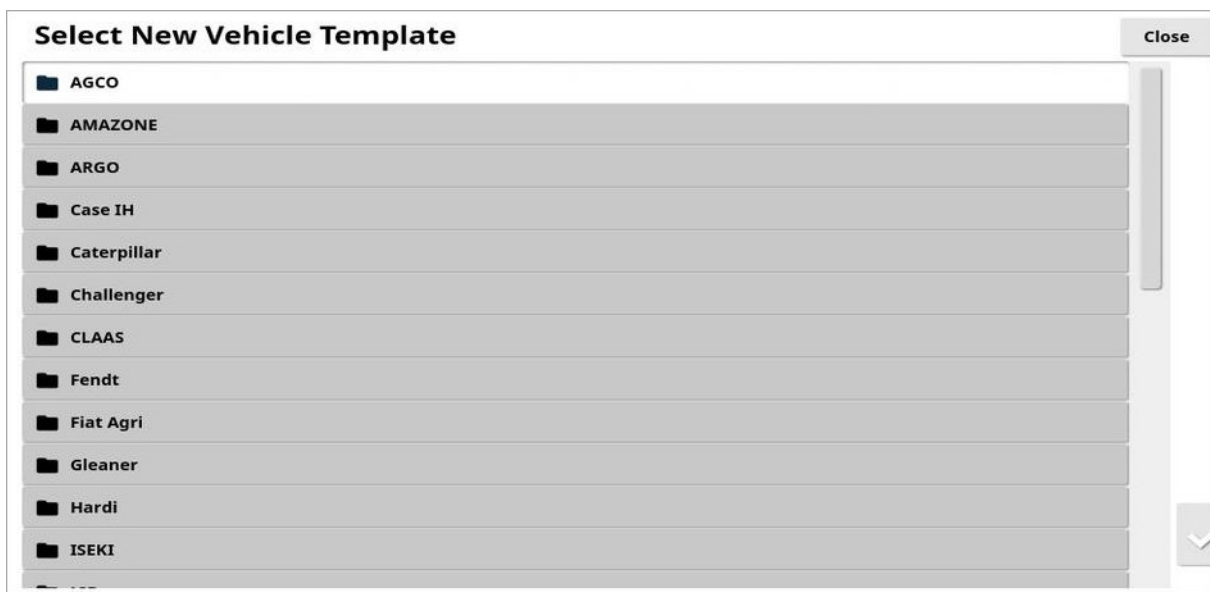

A list of pre-defined factory vehicle templates displays. Templates contain standard measurements and steering parameter information where this is available.

Measurements can be adjusted to correct for the particular vehicle, tire size and so on when geometry is confirmed in the following section.

Steering parameters control how the vehicle will respond to guidance and these can be fine-tuned later in the process in [Auto Steering, page 219](#). If steering continues to be unsatisfactory once setup is complete and after tuning the auto steering, contact your dealer.

2. Select the vehicle manufacturer. Use the scroll bar to see the complete list. If the required manufacturer is not available, select one that is most like the vehicle being used. If none of the choices are appropriate, select **Other** and go to [Customizing a vehicle, page 97](#).

Note: Select  to go up one level to the parent folder.

3. Select the vehicle model and confirm.
4. To change the name, select **VEHICLE NAME**, enter the name and confirm.



5. Confirm the new vehicle. The Vehicle Geometry screen displays.
6. Go to [Setting the vehicle geometry, page 99](#).

6.2.1. Customizing a vehicle

When **Other** is chosen from the Vehicle Template screen, generic vehicle templates are displayed that hold basic vehicle information and steering parameters.

1. Select **Other**. A list of steering controllers displays:
 - **ACU-1**: Autosteering Control Unit
 - **AES**: Accurate Electric Steering
 - **AF**: AutoFarm[®] valve block
 - **RST**: Raven SmarTrax[™] valve
 - **Other**: Any other steering controller
2. Select from the list and confirm. A range of generic vehicle templates displays.
3. Use the arrows to select the template shape most like your vehicle and confirm.
4. To change the name, select **VEHICLE NAME**, enter the name and confirm.

6.2. Creating a new vehicle



5. Confirm the new vehicle. The Vehicle Geometry screen displays.
6. Go to [Setting the vehicle geometry, page 99](#).

6.3. Setting the vehicle geometry

Sets the vehicle measurements so that guidance can work accurately.

Note: Measure the vehicle dimensions as accurately as possible. The recommended tolerance is +/- 5 cm.

To set the vehicle geometry:

1. Select **Vehicle**  / **Geometry** . Alternatively, the Vehicle Geometry screen displays automatically when a vehicle is created or selected.

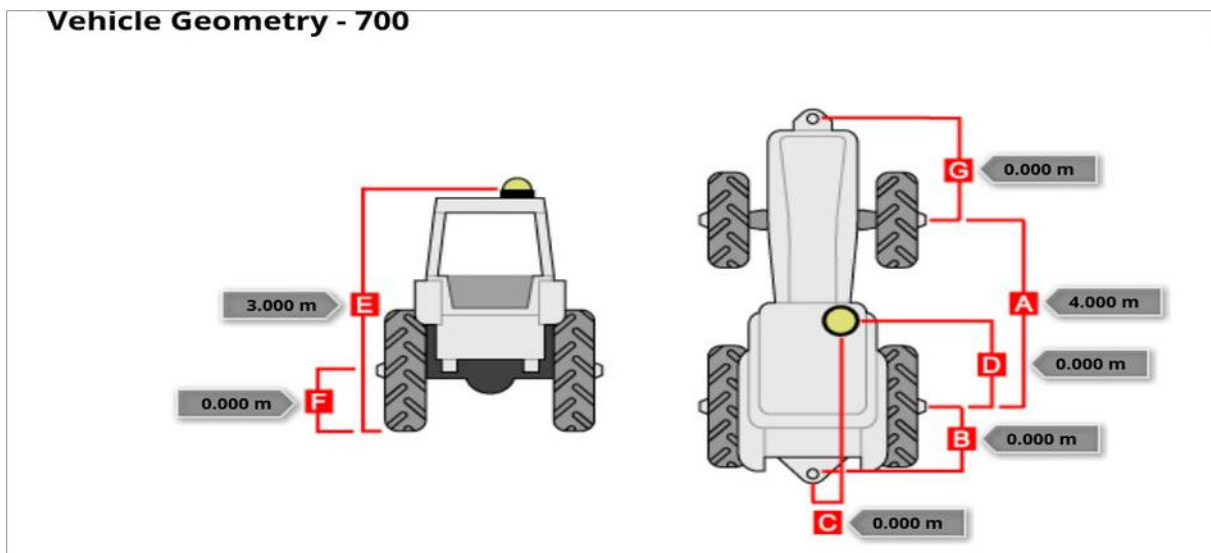

2. Select a vehicle dimension.

Dimensions requested vary according to the type of vehicle selected.

3. Add or adjust dimensions where needed and confirm.

The following lists key measurements commonly used in the system:

- **Wheelbase:** The distance from the center of the front axle to the center of the rear axle.
- **Implement Tow Point:** The distance from the center of the rear axle to the tow point.

6.3. Setting the vehicle geometry

- **GPS Steer:** The offset left or right from the middle of the axles to the GPS receiver. This is a positive number if the receiver is to the right of the middle of the axle and negative if the receiver is to the left.
- **GPS Antenna:** The horizontal distance of the receiver from the center of the rear axle. The number is positive when the receiver is in front of the rear axle and negative if it is behind the rear axle.
- **GPS Height:** The height of the top of the GPS receiver above the ground.
- **Axle Height:** The height of the axle above ground.
- **Front Hitch:** The distance from the center of the front axle to the front hitch position.
- **Track Spacing:** This only applies to tracked vehicles and is the distance between the tracks.
- **Articulation Point:** This only applies to articulated vehicles and is the distance from the rear axle to the articulation (pivot) point of the vehicle.

6.4. Setting up the steering controller

Controls how the vehicle will respond to guidance. See [Auto Steering, page 219](#).

This option is only visible if **AUTO STEER** is enabled on **System / Features / Guidance**.

To set up the steering controller:

1. Select **Vehicle**  / **Steering**  .



- **Controller:** **Note:** It is important to select the specific steering controller, if it is listed, so that auto steering settings match the vehicle profile. Note that if the steering controller is changed later, it may be necessary to return to the vehicle geometry to confirm the dimensions (refresh them). Note that **Auto Detect** does not automatically detect the controller options that are available in the list, so the specific controller must be selected if it is an available option.

Selecting AES as the controller adds extra options to the Steering Tuning screen, see [Tuning auto steer, page 224](#).

- **CAN bus:** Controller Area Network. Select the CAN bus being used. If unsure, look at the labeling on the connections to the GPS receiver.
 - **CAN 1:** ISOBUS
 - **CAN 2:** Primary steering BUS
- **Steering engage:** Allows the operator to engage auto steering from the display.

6.4. Setting up the steering controller

- **Virtual:** Select if only the on-screen **Auto Steer Engage** button will be used .

- **Virtual and External Console Input:** Select if you have an external Engage button connected directly to the display.

If you have an external Engage button connected to the CAN bus, you can select either of these two options.

- **Import authorisation key:** To control a Claas Series 2 or John Deere R machine, an authorization code must be purchased from your dealer and entered here.

6.5. Selecting the vehicle antenna

Sets whether the GPS receiver has an internal (built into the receiver) or external antenna. Internal antenna is set as default.

To set the antenna type:

1. Select **Vehicle**  / **Antenna**  .

Antenna Setup
Close



ANTENNA TYPE

External



FORWARD OFFSET TO AGI-4:

0.000 m



RIGHT OFFSET TO AGI-4:

0.000 m



HEIGHT

0.000 m

If **External** is selected, the measurements for the location of this antenna must be entered:

- **Forward offset to AGI-4** (or AGI-3): Enter the distance forward from the center of the AGI-4 to the center of the antenna (use a negative number if the antenna is behind).
- **Right offset to AGI-4** (or AGI-3): Enter the distance to the right from center of AGI to center of antenna (use negative number if antenna is to the left of the AGI).
- **Height:** Enter the height of the antenna above the ground.

6.6. Setting up GPS speed emulation

Sends vehicle speed information to the ISOBUS implement for performing rate control or other functions.

1. Select **Vehicle**  / **Speed & Position** .

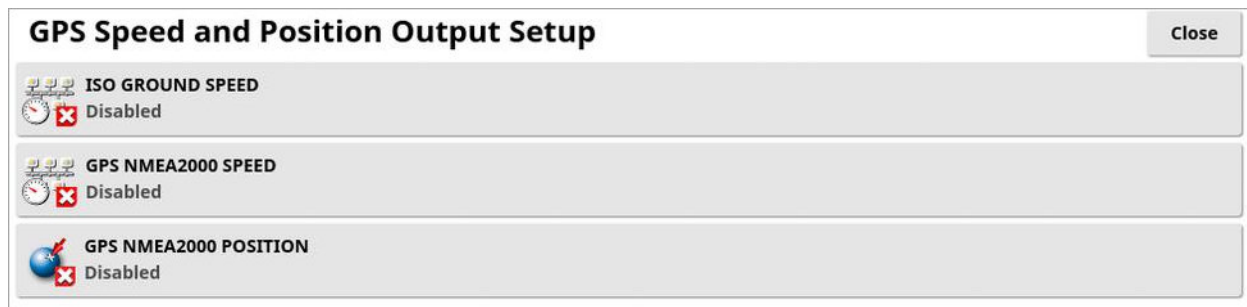

Outputs speed on ISO and/or NMEA2000 bus to the ECU.

Note: The GPS NMEA2000 setting specifies that the virtual TECU should emulate NMEA 2000 COG/SOG messages (129026) if they are not already present on the bus. It has no effect on the NMEA 2000 output sent from the receiver.

2. Select the required output/s.

Chapter 7 – Implement Setup

This chapter explains how to configure the implement(s) being used with the system.

Topcon displays now allow multiple implements to be connected at the same time. There can be any number of ISOBUS implement controllers and ONE specific implement controller in the list below active at one time.

- ASC-10
- IB-2
- Apollo
- Scraper
- Yield Monitor
- Non-controlled (not controlling sections or rate e.g. a plow or mower)
- Raven Sprayer Xlink
- Hardi 5500 Xlink
- Hardi 6500 Xlink
- Bravo Sprayer Xlink
- Väderstad Seeder Xlink
- Flexicoil Seeder Xlink
- Amatron+ Xlink
- Bogballe Xlink
- Kverneland Xlink
- LH5000 Xlink
- Kuhn Spreader Xlink

Note: The listed implement controllers have customised user interfaces on the Horizon display, which allows only one to be active at a time. These implement profiles must be manually created (see [Setting up a new implement, page 112](#)). If the display is to be used with more than



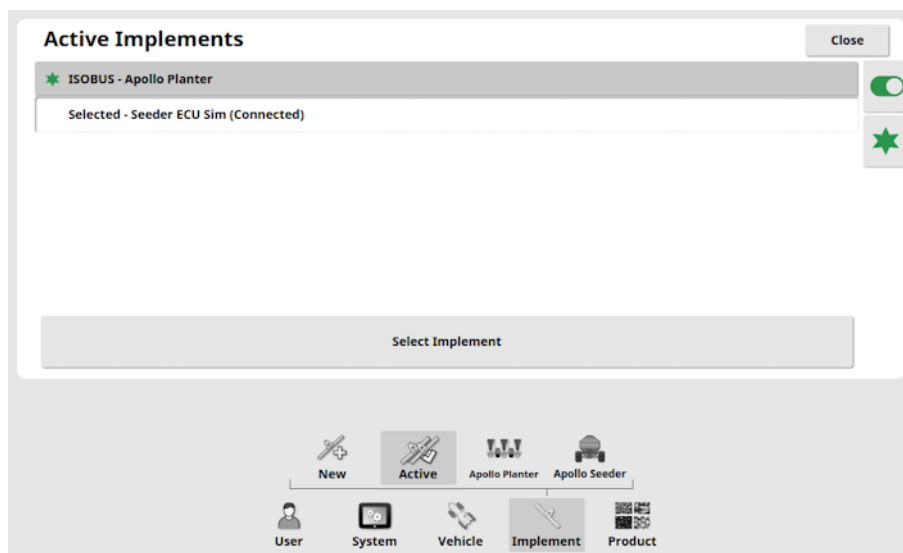

one profile listed above, then more than one implement profile must be created. These profiles are shown with 'Selected' at the start of the profile name.

ISOBUS implement profiles (not listed above) are automatically generated and made active when an ISOBUS ECU is detected on the bus (if the ECU has an enabled Task Controller (TC)). These profiles are shown with 'ISOBUS' at the start of the profile name. The profile will disappear from the active list if the ECU is disconnected from the bus.

1. To display the active implement profiles, select **Implement** / **Active** .



- **ISOBUS:** Shown next to an automatically detected ISOBUS ECU present on the bus.
- **Selected:** Shown next to an implement profile that was manually created for a specific implement controller in the list above (see [Setting up a new implement, page 112](#)).
- **Select Implement:** Press to select a different implement profile from the list of manually created implement profiles (see [Selecting an implement, page 110](#)).

- **Disconnected:** Shown next to a manually created and selected profile if the physical implement has been disconnected from the vehicle.
- : Shown next to the implement profile selected as the 'primary' implement. The 'primary' implement is used for guidance (line recording, swath width, guidelock, steering with offset implements), boundary recording, Machine Link shared coverage, headland actions, tramlines and flag point alarms. Highlight the required profile and select  to make it the 'primary' implement. This selection can not be performed if a task is active or paused, or the vehicle is currently steering.
- : Can be used to unload a manually created implement profile if no longer required. Highlight the required profile and select .

Note: The currently active implements are displayed on the **Implement** menu.

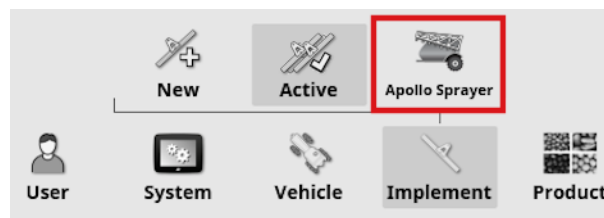

Selecting the profile on the **Implement** menu displays the **Default task name** option. This enables a default name to be entered for all tasks performed using the currently selected 'primary' implement. A number is added to the end of each task name if multiple tasks are performed in the same field. If a default name is not entered, the task name is derived from the implement type and current date.

Implement Setup Close

DEFAULT TASK NAME
 (Implement Name YYYYMMDD)

IMPLEMENT MODEL
 Trailed

If the selected implement is pivoted, the **Implement model** option displays. This is used to specify whether the 'primary' implement is actively steered. This setting ensures the ASC operates accurately and headland turn shapes are correctly generated.

ISOBUS implement connector type

It is possible that for automatically generated ISOBUS implement profiles, the ISOBUS ECUs may not specify the correct implement connector type:



rigid



pivoted (tow behind)



front mount



double pivoted (tow between)

1. To change the selected **Connector type**, select **Implement** / profile and select from the **Connector type** drop down list.

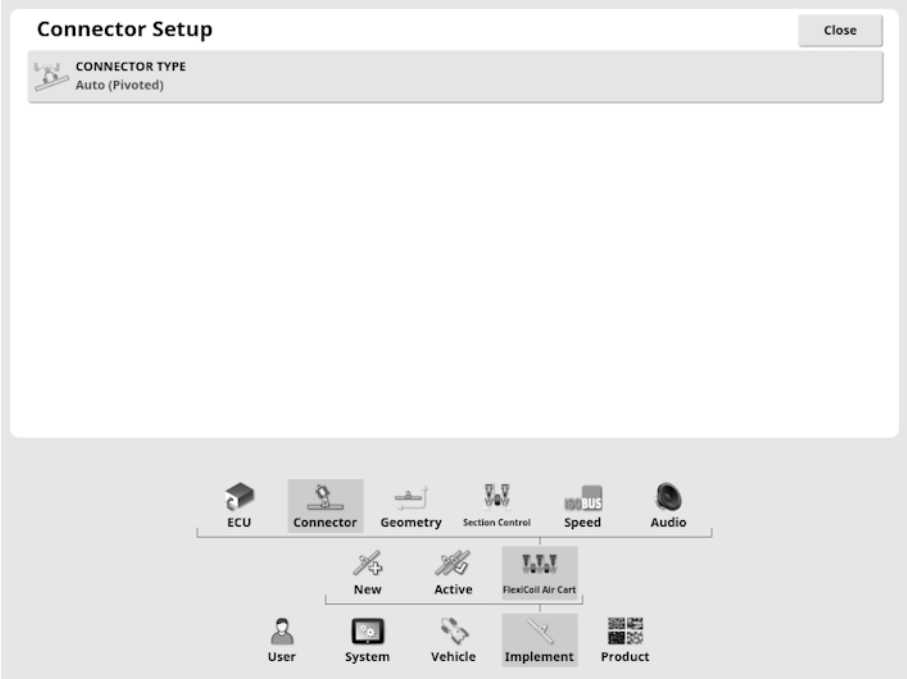

7.1. Selecting an implement

Selects an implement from a list of profiles previously created for the implement types listed in [Implement Setup, page 105](#).

This list is blank when the display is first used.

Topcon displays allow one implement controller from this list and any number of automatically detected ISOBUS implements to be active at one time.

To select an existing manually created implement profile:

1. Select **Implement**  / **Active**  / **Select Implement**.

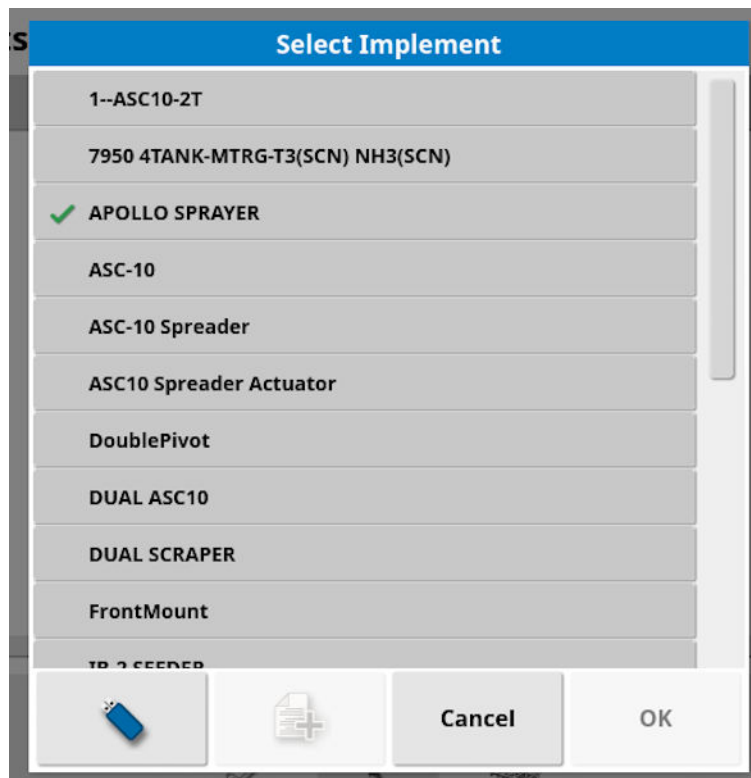

2. Highlight the required implement and confirm, or:



Select to import an implement profile from a USB. **Note:** The implement file must be in a folder on the USB with the following file structure: **Implements / (folder matching the name of the .ini file) / .ini file**. For example **Implements / ASC-10 Spreader / ASC-10 Spreader.ini**



Select to create a copy of the highlighted implement. This profile may then be edited.

Once an implement is selected, a profile for the selected implement displays on the **Implement** menu (e.g. Apollo Sprayer, Yield Monitor etc).

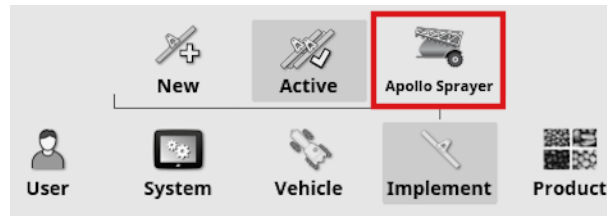

Note: If a manually created implement profile is active, this is the 'primary' profile by default. This means that this profile controls line recording, swath width, boundary recording, headland actions, flag point alarms etc. If there is an automatically generated ISOBUS implement profile that should be selected as the 'primary' profile,

highlight the profile in the **Active** list and select .

7.2. Setting up a new implement

Creates a new implement profile for the specific implement controllers listed in [Implement Setup, page 105](#).

The following information details how to set up a non-controlled implement for correct swath paths or guidelines. This allows the creation of coverage maps and provides waylines for auto steering and guidance.

Refer to the Spreader / Sprayer / Seeder operator manuals for detailed implement information. The following information sets up the implement for auto guidance and steering only.

To create a new implement:

1. Select **Implement**  / **New**  .

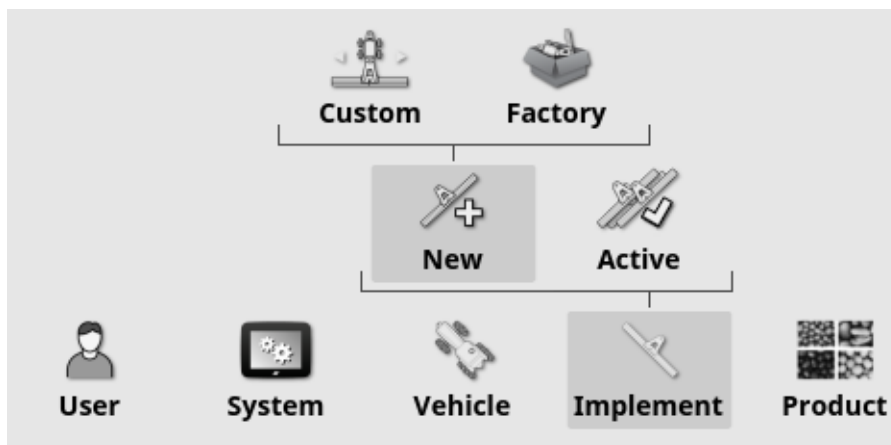

- **Custom:** Create a new implement profile.
 - **Factory:** Select an implement template from a pre-defined list. (X35/XD+ only)
2. If the required implement is not available in the **Factory** templates, select **Custom**.
 3. Use the arrows to select the implement **Type** and confirm.



rigid



pivoted (tow behind)



front mount



double pivoted (tow between)

A default name for the implement is displayed.

Note: It is highly recommended that items are named in a thoughtful and structured way to allow easy use in future seasons.

4. To change the default name, select **IMPLEMENT NAME** and enter the new name, then confirm.

The New Implement Setup wizard displays.

5. Select **ECU TYPE**, select **NONE**, then confirm and select next.
6. Select **IMPLEMENT CONTROL** and select the required option:
 - Section control only
 - Section control and rate control. (Select this if you require the option to load and view a VRC map.)
7. Select **IMPLEMENT FUNCTION** and select the most appropriate option from the selection list.

Note: Select **Sprayer** for liquid tanks, **Spreader** for granular tanks or **Other** for a combination of liquid and granular tanks as you might have with a seeder.

8. When the screen shows that the setup is complete, confirm.

Once created, the implement profile displays on the **Implement** menu. The profile name is derived from the implement type (e.g. Apollo Sprayer, Yield Monitor etc).

7.2. Setting up a new implement



9. Select the implement profile to continue setup. See [Setting the implement geometry, page 115](#).

7.3. Setting the implement geometry

Sets the implement measurements so that guidance can work accurately.

Note: Measure the implement dimensions as accurately as possible. The recommended tolerance is +/- 5 cm. When an ISOBUS implement is connected, some of the geometry items are provided by the implement and cannot be altered on this screen. Any changes to these must be made in the implement ISOBUS UT control screen.

To set the implement geometry:

1. Select **Implement**  / profile / **Geometry** .

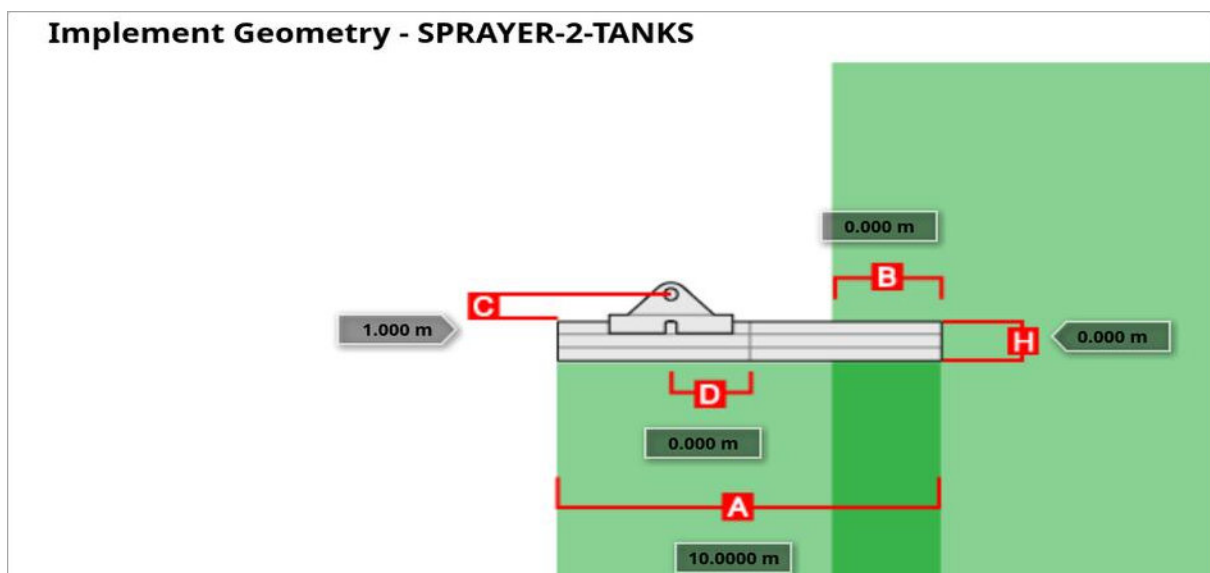

2. Select an implement dimension. The name of the dimension appears in the title bar.
Dimensions requested vary according to the type of implement selected.
3. Add or adjust dimensions where needed and confirm.

The following lists measurements used in the system:

- **Swath Width:** Measures the working width of the implement (that is, the width of the area that is treated during one pass of the implement).

7.3. Setting the implement geometry

- **Working Length:** Length from the start to the finish of the working area of the boom. Together with swath width, it defines the 'Working Area', which is the region that product is applied over for that boom.
- **Overlap:** Measures the width of the overlap between two adjacent passes.
- **Implement Offset:** Measures the distance between the hitch point and the wheels of the implement.
- **Implement Wheels Offset:** Measures the distance between the wheels and the working area of the implement.
- **Inline Offset:** Measures the off-center offset of the implement relative to the hitch point. Enter a positive number if the implement is shifted to the right and a negative number if it is shifted to the left.
- **Trailer Offset:** Measures the distance between the trailer hitch point and the trailer wheels.
- **Trailer Wheels Offset:** Measures the distance between the implement hitch point and the trailer wheels.

Note: If the implement has multiple booms, the boom that is to be used for guidance must be selected from the **BOOM FOR GUIDANCE** selection list. This determines the swath width (spacing for the guidance lines). The implement geometry must be set for each boom on the numbered tabs.

4. If the implement is pivoted and has active steering, select **Implement**



/ profile and select **Active steering** from the **Implement model** option. This setting ensures the ASC operates accurately and headland turn shapes are correctly generated.

7.4. Setting up section control

The display can support up to 30 sections if using three ASC-10 ECUs.

To set up section control:

1. Select **Implement**  / profile / **Section Control**  / **Sections**



(Select **Implement**  / profile / **Boom**  if there are multiple booms.)

Section Setup - SPRAYER-2-TANKS			
SECTIONS 1			
Section	Width (10.0000 m)	Low Speed Shutoff	Nozzles (1)
All	1/1	1/1	1/1
1	10.0000 m	0.0 km/h	1

2. Select **SECTIONS** and use plus or minus to set the number of sections, then confirm.
3. To set the section width for all sections, select **Width** next to **All**.

Section Setup - SPRAYER-2-TANKS			
SECTIONS 1			
Section	Width (10.0000 m)	Low Speed Shutoff	Nozzles (1)
All	1/1	1/1	1/1
1	10.0000 m	0.0 km/h	1

4. Enter the section width for all sections and confirm.
5. To set individual widths for sections, select the width next to a section, enter the width and confirm.
6. Repeat for each section.

Refer to the Spreader / Sprayer / Seeder operator manuals for more information.



7.4.1. Setting timing

These settings set the response times for the sections when switched on or off. It is important to accurately calculate the response times to avoid overlaps or gaps in product application.

To calculate the response times:

1. Ensure the implement is ready to begin product application and that the calibration factor for the product has been calculated (see [Product Setup, page 123](#)).
2. Use a stop watch to time the delay between switching a section on and the application of product. This is the **ON TIME**.
3. When the section is switched off, time the delay between switching it off and the product ceasing to flow. This is the **OFF TIME**.

To set the response times:

1. Select **Implement**  / profile / **Section Control**  / **Timing** .
2. Select **ON TIME** to set how many seconds delay there is between switching a section on and the application of product, then confirm.
3. Repeat for **OFF TIME** and confirm. This will set how many seconds delay there is between switching a section off and stopping product flow.

Adjusting timing for overlap and underlap

It may be necessary to adjust the on and off time if overlaps or gaps in product application are observed.

If gaps are observed when entering a headland:

If when entering the headland into a sprayed area, sections turn off too early leaving a gap of unsprayed area, this means the off time is too long and must be reduced.

Example: The vehicle is spraying at 18 km/h and the gap is about 1 m. At 18 km/h, the sprayer covers 5 metres per second ($18/3.6 = 5.0$), so the off time must be decreased by $1 \text{ (m)} / 5 \text{ (m/s)} = 0.2 \text{ s}$.

If gaps are observed when leaving a headland:

If when leaving the headland into an unsprayed area, sections turn on too late leaving a gap of unsprayed area, this means the on time is too small and must be increased.

Example: The vehicle is spraying at 27 km/h and the gap is about 2 m. At 27 km/h the sprayer covers 7.5 metres per second ($27/3.6 = 7.5$), so the on time must be increased by $2 \text{ (m)} / 7.5 \text{ (m/s)} = 0.27 \text{ s}$.

If overlap is observed when entering a headland:

If when entering the headland into a sprayed area, sections turn off too late causing an overlap in the sprayed area, this means the off time is too small and must be increased.

Example: The vehicle is spraying at 18 km/h and the overlap is about 0.5 m. At 18 km/h, the sprayer covers 5 metres per second ($18/3.6 = 5.0$), so the off time must be increased by $0.5 \text{ (m)} / 5 \text{ (m/s)} = 0.1 \text{ s}$.

If overlap is observed when leaving a headland:

If when leaving the headland into an unsprayed area, sections turn on too early causing an overlap of sprayed area, this means the on time is too large and must be reduced.

Example: The vehicle is spraying at 27 km/h and the overlap is about 1.5 m. At 27 km/h the sprayer covers 7.5 metres per second ($27/3.6 = 7.5$), so the on time must be decreased by $1.5 \text{ (m)} / 7.5 \text{ (m/s)} = 0.2 \text{ s}$.



7.4.2. Setting up the section switch

The section switch can be either Virtual (on the display screen) or External (a physical switch connected to the ECU or display).

7.4. Setting up section control

The type of switch cannot be selected with spreaders as the spinners' on/off action controls the two sections.

To configure the switches:

1. Select **Implement**  / profile / **Section Control**  / **Section Switch**  .
2. Select **TYPE**.
3. Select **Virtual** or **External ECU Sense** and confirm.

7.5. Setting up the master switch

The master switch turns on the application control (spreader, sprayer, seeder) and also enables the coverage map on the guidance screen.

To set up the master switch:

1. Select **Implement**  / profile / **Master Switch**  .

Note: If an Apollo seeder or sprayer implement is connected, this option is under **Implement** / profile / **Operator Inputs** / **Master Switch**. Refer to the implement Operator Manual for more information.

Virtual

Enables the master switch to be operated by selecting the virtual master switch on the display Operation screen.

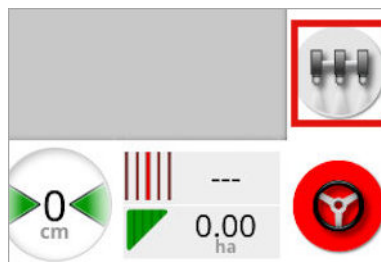

Refer to the manual for the implement controller for information on setting up the switches for the implement.

External console input

Enables the master switch to be operated via an external switch (a physical switch box / master switch connected to the display).

Note: If an external switch is connected, this is usually done by the dealer during installation. The cable labeled 'Remote Mapping' connects to the display harness and provides power to activate / deactivate coverage map and master switch input.

External ECU sense

Enables the master switch to be operated via an external switch (a physical switch box / master switch connected to the ECU).

Steering engage and virtual

Steering engage triggers the master switch. Disengaging steering turns off the master switch. If a remote steering engage switch is being used it will have the same behavior. The virtual master switch button may still be used to toggle the master switch state without changing the steering engage state.

Chapter 8 – Product Setup

8.1. Setting up the product database

Product definitions can be saved in one common area. This allows common products to be used across a range of rate controllers without having to enter each product name and rate repeatedly.

Pre-set rates, increments and product densities can be set up and saved to be recalled in the appropriate rate controller.

The calibration factor for each product is assigned to each implement tank or bin. This means, for example, that you could have urea saved once with different calibration figures for each bin.

Refer to the Spreader / Sprayer / Seeder operator manuals for detailed product information.

The **Product** menu option allows granular, liquid and NH3 (ammonia) product definitions to be created.

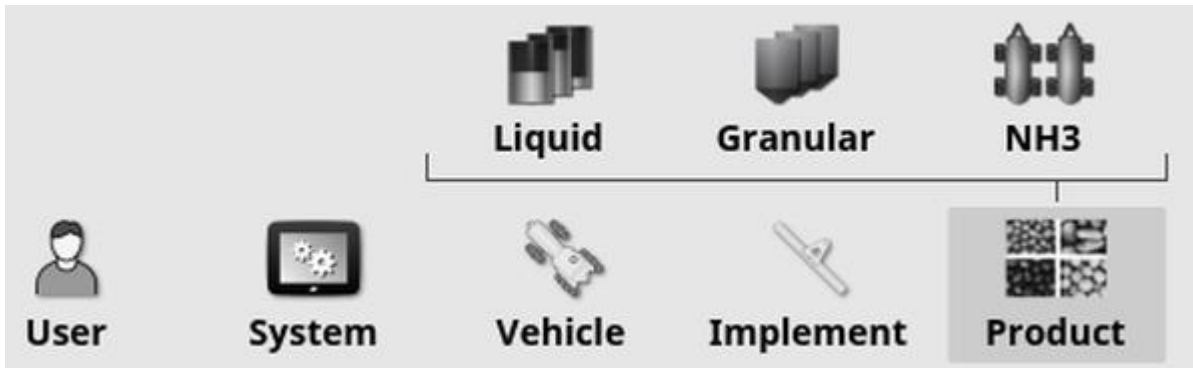

For each product, the following information must be defined:

- **Density** (granular only): Product density is used with tank volumes to determine tank capacities. Defined as kg/L or lb/gal.
- **Rate increment**: Defines how much the application rate will change when the operator presses the application rate up/down button. The rate can be changed by a fixed rate or by a percentage of the rate set for **Rate Preset 1**. See [page 29](#).
- **Rate preset 1 / Rate preset 2**: Defines preset application rates.

8.1. Setting up the product database

- **Calibration factor:** This is the amount of product dispersed per revolution of the product metering unit for granular products and the number of pulses from the flow meter per litre of liquid. This value can be viewed here but must be set for each implement and product. Refer to the Spreader / Sprayer / Seeder operator manuals for more information.

Chapter 9 – Operation Basics

9.1. Using mini-views

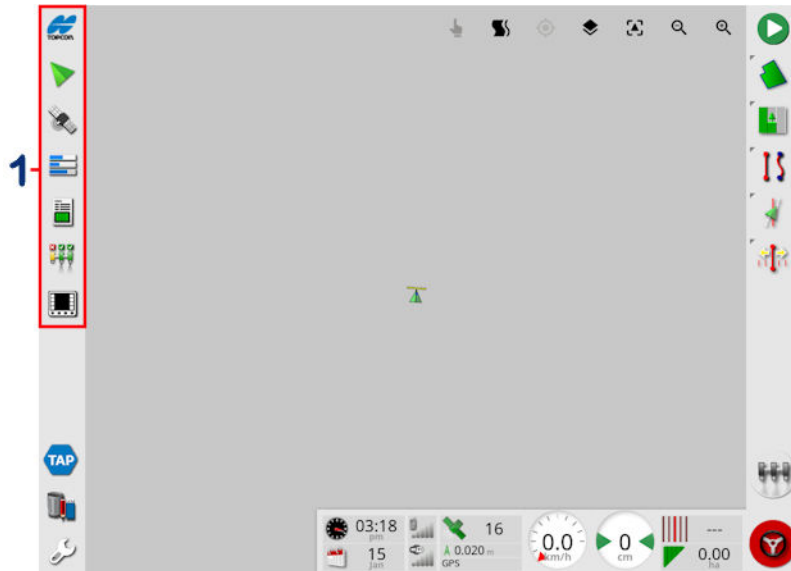

1 Navigation bar

Mini-views may be opened by selecting any feature on the Navigation bar.

Some mini-views have a maximize arrow. These may be expanded to display in full screen view by selecting the arrow or by swiping left to right across the mini-view (ending the swipe to the right of the mini-view screen).

Note: If the mini-view can be expanded to full screen, this can also be done by swiping left to right on the icon in the navigation bar.

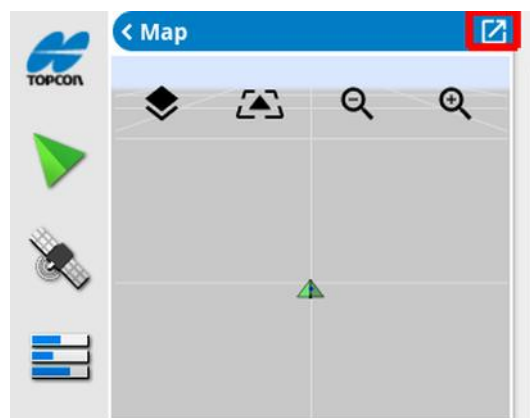

9.1. Using mini-views

To move the mini-view up or down, touch anywhere within the mini-view and slide it in the desired direction. The mini-view will start moving once your finger moves outside its area. (Not applicable to the XD display.)

To close the mini-view, select the feature on the Navigation bar again, select the top left arrow or touch anywhere within the mini-view and slide it to the left into the navigation bar.

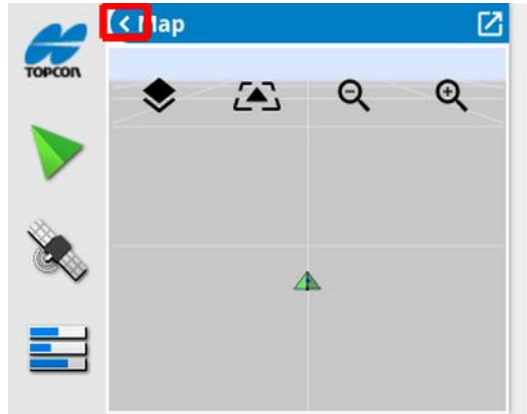

There is no minimize arrow on the full screen view. Expand another mini-view to replace the information on the main screen.

9.2. Viewing system information

The Topcon logo button on the Navigation bar is used to display software and system information summaries.

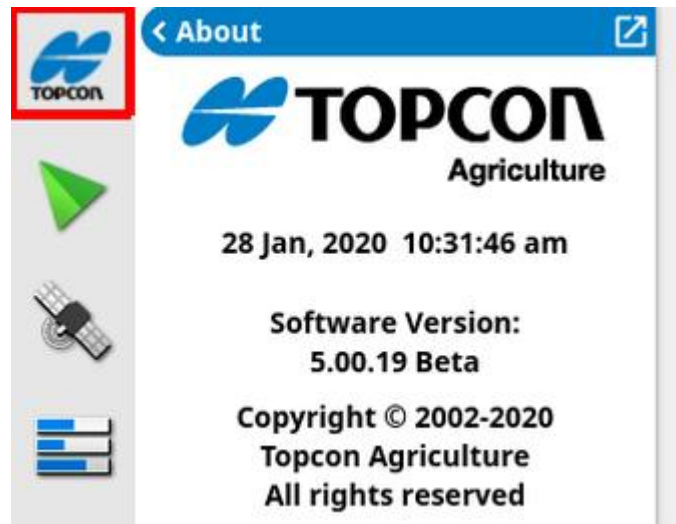

Maximize the mini-view to see the full **System Information** panel.

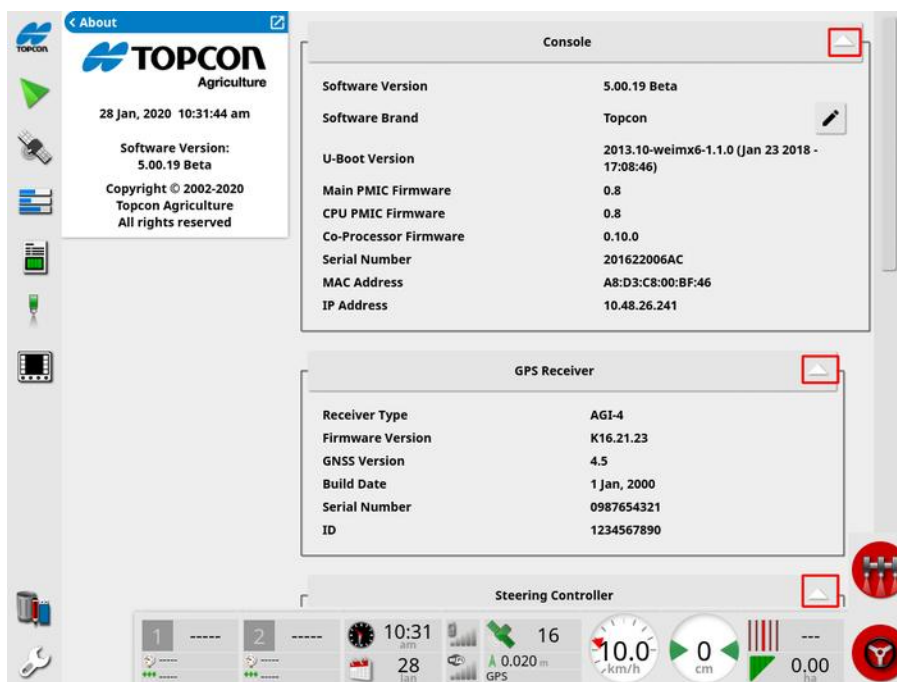

Use the arrows to expand or hide information. A scroll bar displays when needed.

9.3. Viewing guidance

The full guidance screen opens by default when the Operation screen is accessed for the first time. It can also be viewed in a mini-view.

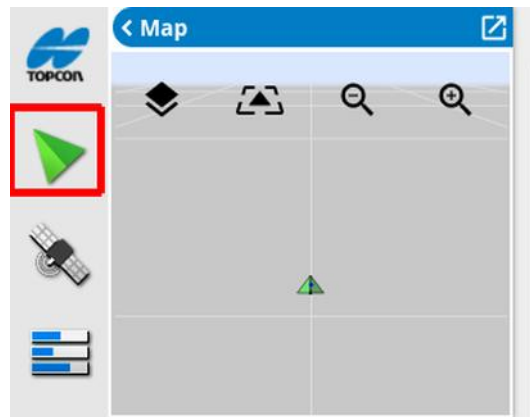

9.3.1. Guidance color scheme

Elements on the guidance screen are represented with the following colors:

- grey: field
- light grey: grid lines
- dark blue: boundary of currently selected field
- medium grey: boundary of non-current field
- dark red: inactive guideline
- red: steer line
- orange: headland
- purple: tramlines

9.3.2. Using view controls

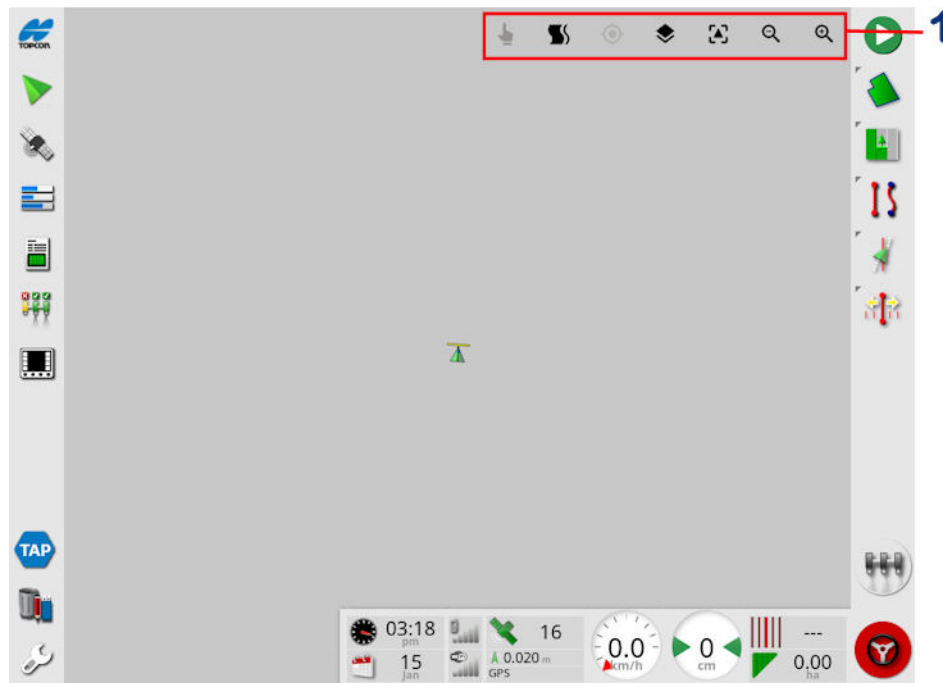

1 View controls

 Select mode, see [Select mode, page 130](#).

 Display headland turn alarm, see [Edit headland turns via alarm, page 213](#).

 Toggle in and out of guidelock mode. See [Using guidelock guidance mode, page 195](#).

 Touching this icon re-centers a panned map to the current location of the vehicle. See **Map panning** on [page 35](#).

 Select visible map layers, see [Map layers, page 130](#).

 Toggle map view mode, see [Toggle map view mode, page 133](#).

 Zoom in / out, see [Map zoom, page 134](#).

9.3.3. Select mode

To use select mode, press and hold on the screen for half a second then drag your finger over the required object to select it. Once the mode is

engaged, the select mode icon turns green  and the object is highlighted.

Note: If operating in a bumpy environment, pressing the select mode

icon  at the top of the screen activates select mode (icon turns green) and disables map panning to avoid inadvertently panning the map while trying to select an object.

This function is available for the following objects on the operation screen:

- boundaries (see [Editing a boundary, page 172](#))
- flag points (see [Working with flag points, page 166](#))
- guidelines (see [Guideline Menu, page 187](#))
- water conservation benchmarks

9.3.4. Map layers

1. Select  to choose which coverage and information layers will appear on the screen.

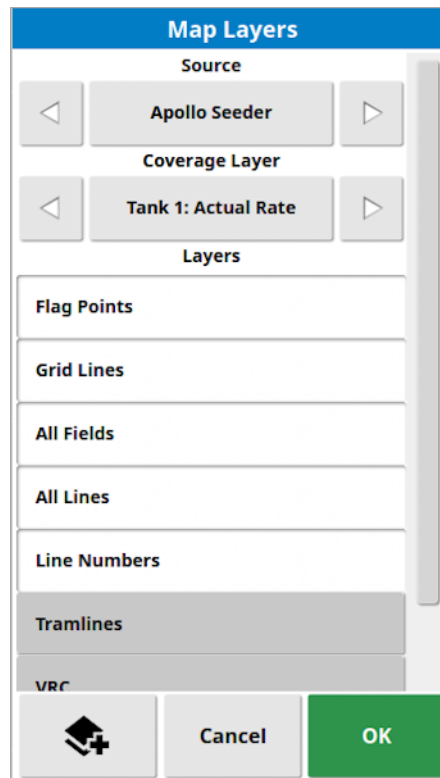

Source

Select the device that will be the source of the map layer information.

Coverage layer

The coverage layer selector is used to select the coverage layer that will be displayed on the map. This is done by pressing the center button and selecting from a list or by pressing the left/right arrows to scroll through the list with a live preview of that layer in the map in the background.

If the desired coverage layer is not present in the list of available layers,

select  at the bottom of the window, then select from the list of coverage layer types to add or remove coverage layers. The available coverage layer types depends on the source being used.

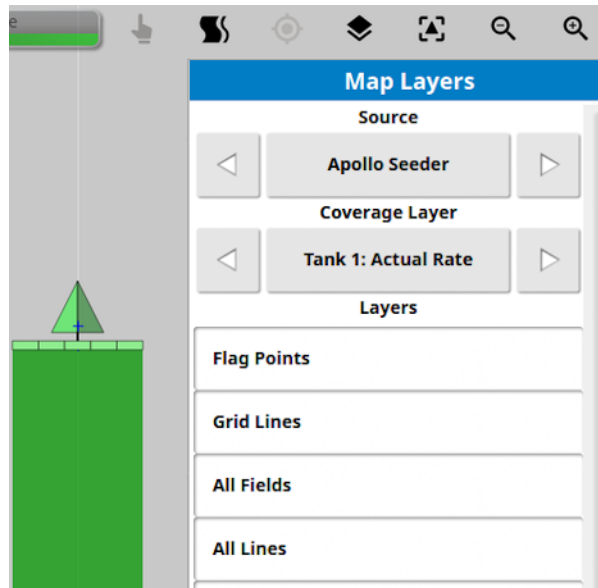

Coverage shows in green. Applied rate shows in selectable colors (see below for instructions on how to change these colors).

Select visible map layers

- **Flag points:** See [Setting flag points, page 165](#).
- **Grid lines:** Show grid lines on the guidance screen.
- **All fields:** Displays all nearby defined fields.
- **All lines:** Displays all guidelines in the field.
- **Line numbers:** Displays guidelines as a row of numbered lines across the field (applies only to AB Lines).
- **Tramlines:** Display tramlines. See [Setting up tramlines, page 203](#).
- **VRC:** Enables a VRC map layer to be displayed (only available if Variable Rate Control is enabled on the Setup screen (System / Features / Implement)).
- **Applied rate:** Select to display the actual rate that has been applied (if the selected coverage layer contains variable rates), or leave unselected to display only coverage (see **Coverage layer** above).

Editing the applied rate legend



A legend is displayed at top of the map when Applied Rate or VRC is selected and the selected coverage layer contains a variable rate. The colors may be edited.

1. Select the legend to display the legend color and range map.

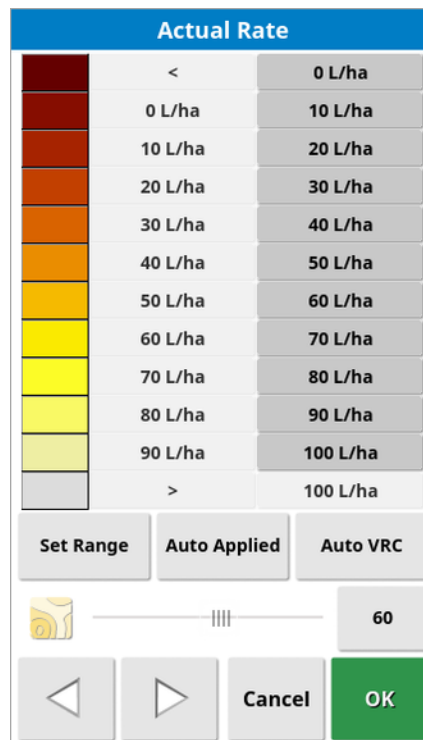

- **Set range:** Manually adjust the colors and ranges used.
 - **Auto applied:** Automatically adjust the colors and ranges to match the application rates that have been recorded in the active task.
 - **Auto VRC:** (only available when Variable Rate Control is enabled) automatically adjust the colors and ranges to match the rates that are used in the task prescription.
2. Use the left and right arrows at the bottom of the rate legend editor to select the color theme that will be used by the rate legend.

If Variable Rate Control is enabled, the slider at the bottom of the rate legend editor can be used to adjust the opacity of the VRC map layer.

Toggle map view mode

1. Select  to toggle views of the map (North Up, Overhead or Perspective).

9.3. Viewing guidance

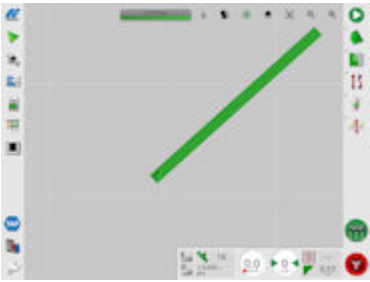

In North Up View  the top of the screen represents North.



In Overhead View  the top of the screen represents the vehicle's current direction.

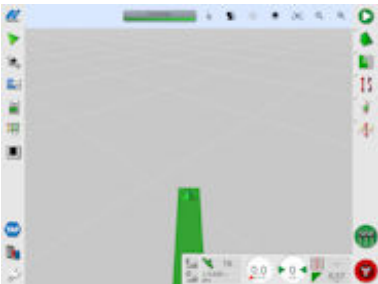

Perspective View  places the map into virtual perspective with a virtual horizon.

Map zoom

Select  to zoom in or out if needed. Press and hold to zoom quickly.

9.4. Viewing GPS details

To view and monitor GPS information:

1. Select **GPS Information**  from the **Navigation bar**.

GPS Position tab

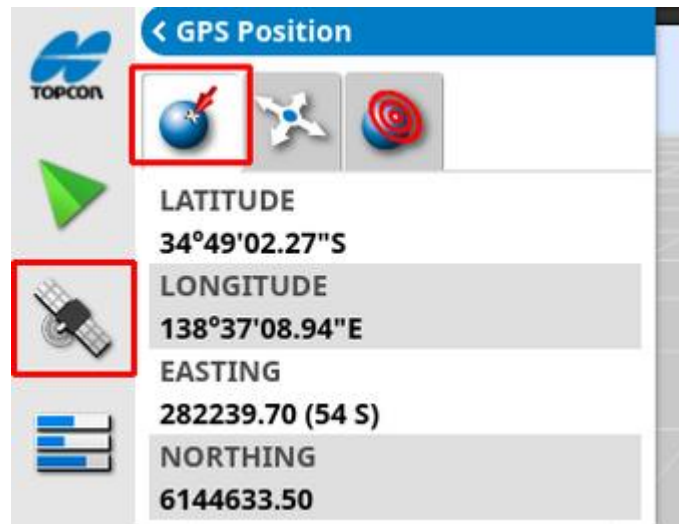

Latitude and Longitude show the positioning of the vehicle.

Easting and Northing shows the Universal Transverse Mercator (UTM) position and zone of the vehicle. They are measured in meters.

The grid numbers on the east-west (horizontal) axis are called Eastings, and the grid numbers on the north-south (vertical) axis are called Northings.

Vehicle orientation tab



This shows altitude, heading (degrees), actual speed of the vehicle and roll/pitch (degrees). Roll is the left/right tipping of the vehicle. Pitch is the forward/back tipping of the vehicle.

GPS accuracy tab

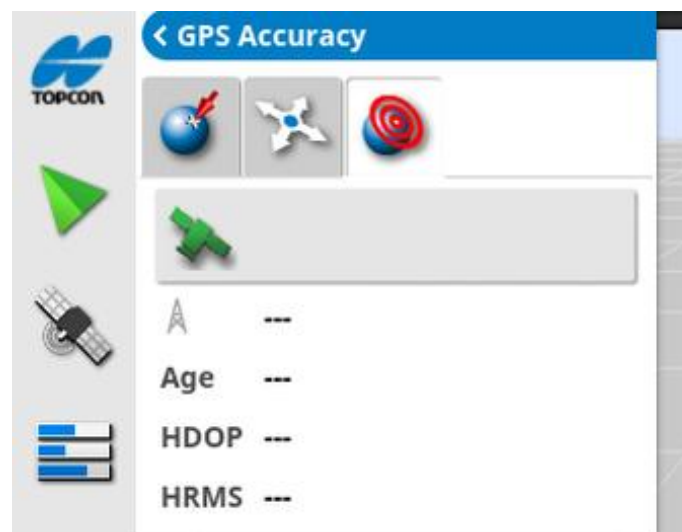

This displays the number of available satellites, the correction age (seconds) and the HDOP (lower value indicates better accuracy) and HRMS (lower value indicates better accuracy).

Note: The HDOP (Horizontal Dilution of Precision) indicates the effect on accuracy of a number of satellite sources and their geometry. Keep the antennae clear of obstructions to maintain accurate GPS readings.

HDOP < 1.0	Good accuracy
HDOP between 1.0 and 4.0	Average accuracy
HDOP > 4	Poor accuracy
GPS invalid 0	No signal

The HRMS (Horizontal Root Means Squared) calculates an average horizontal position from the source information from the satellites.

9.5. Viewing diagnostics

To view diagnostic information:

1. Select **System Diagnostics**  from the **Navigation bar**.

Memory usage tab

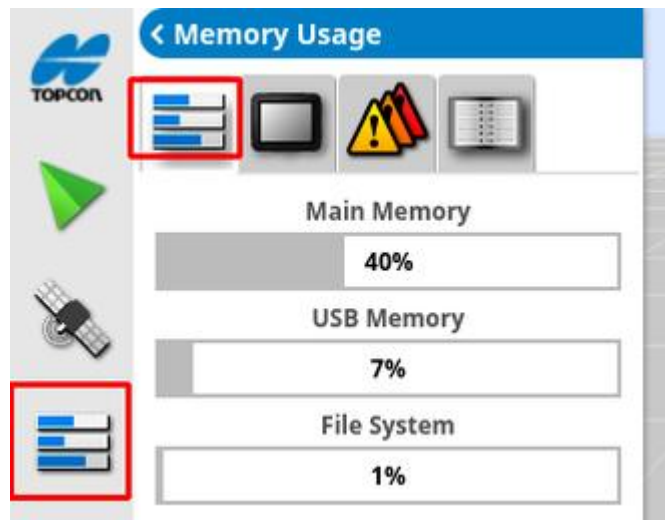

Console diagnostics tab

Display status information is shown.

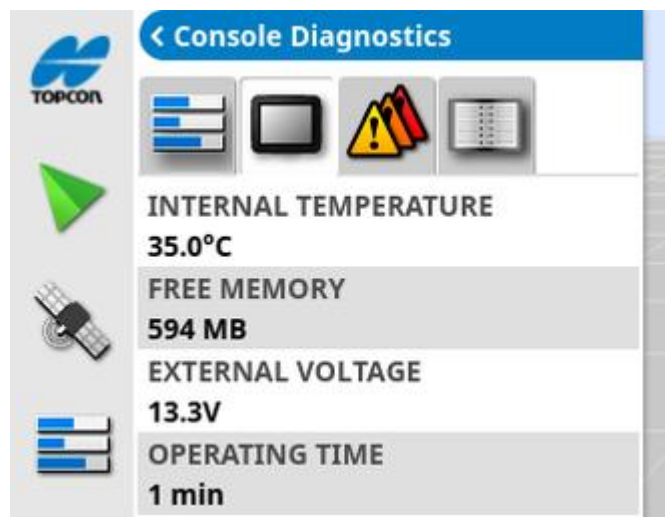

Trouble codes tab

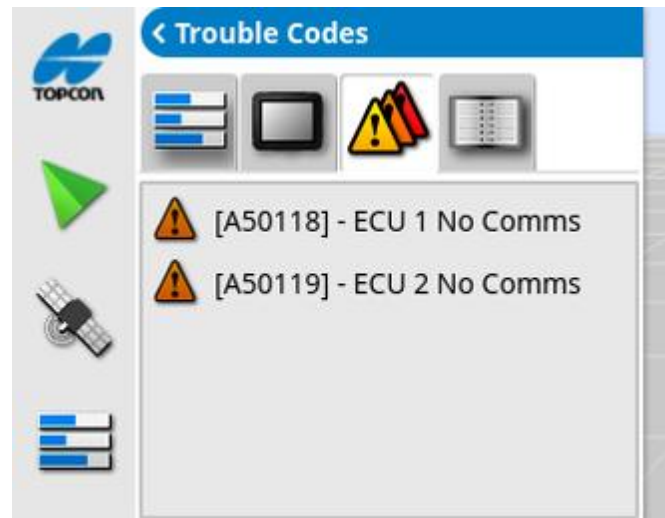

Error messages are listed. If problems do happen, take note of these for customer support personnel.

Logging tab

The **Logging** tab is used by customer support personnel. However, if Topcon support personnel send a logging configuration file, it can be loaded from USB and run using this screen.

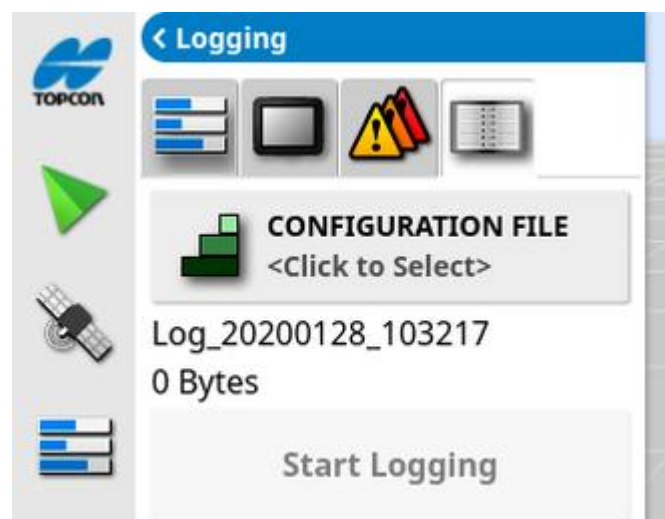

9.6. Viewing task information

To view task information:

1. Select **Task Information**  from the **Navigation bar**.

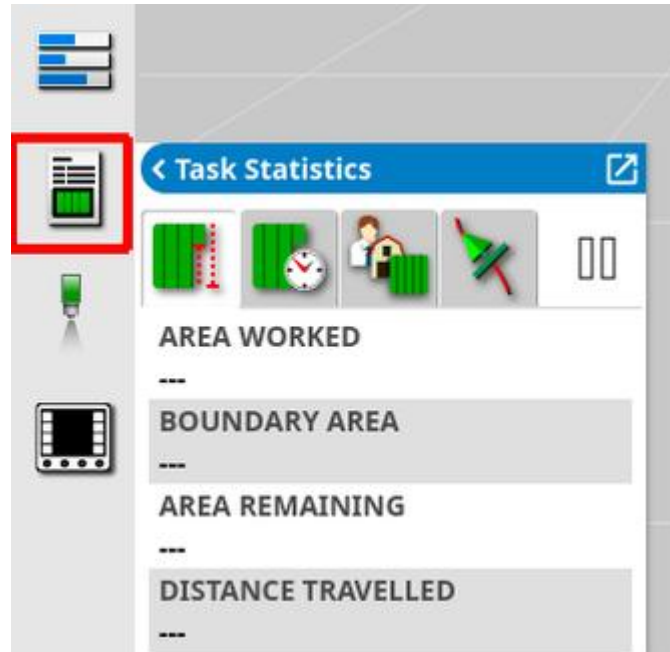

This shows overall information on the task's progress.

2. Maximise the mini-view and select **Record task details** to enter and review notes about the crop, weather and site conditions.

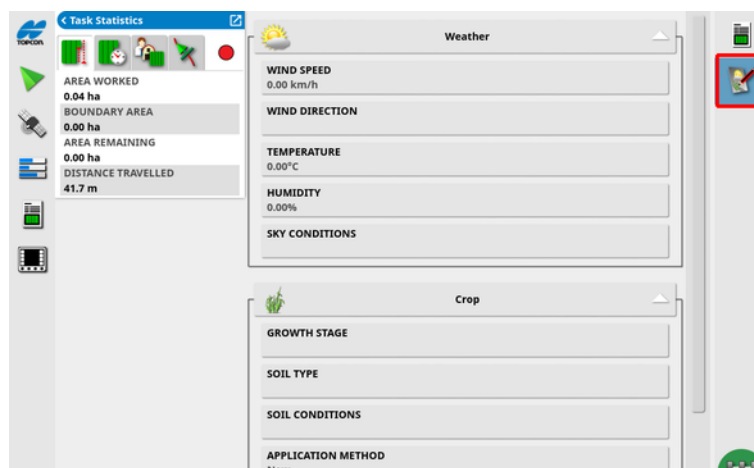

3. To view other information, select the following tabs.



Task duration



Task settings



Guidance settings

If an implement with more than one boom is selected, an icon is displayed to select the boom about which to view information.

9.7. Monitoring on the dashboard

The display on the dashboard can be adjusted.

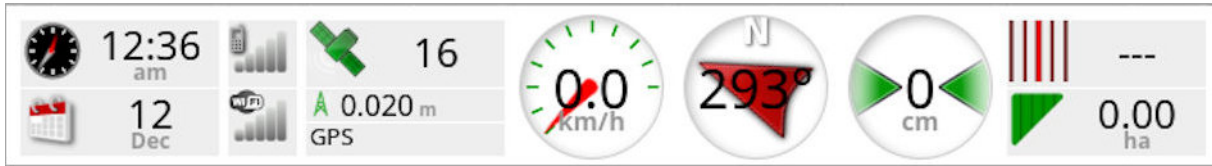

9.7.1. Customizing the dashboard

1. Select anywhere on the dashboard to customize what is shown on the dashboard.
2. Press again on the particular panel to be customized and further options display.
3. Deselect and select options as required.
4. Confirm the new dashboard display. The chosen options appear on the dashboard.

Time and date

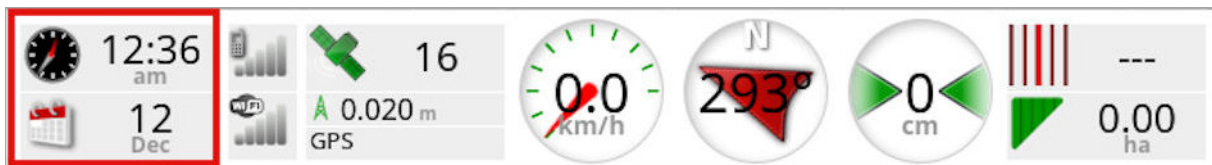

Time is set via the Setup screen, **User / Region / Time/Date**. Date is supplied via the GPS signal.

Signal strength

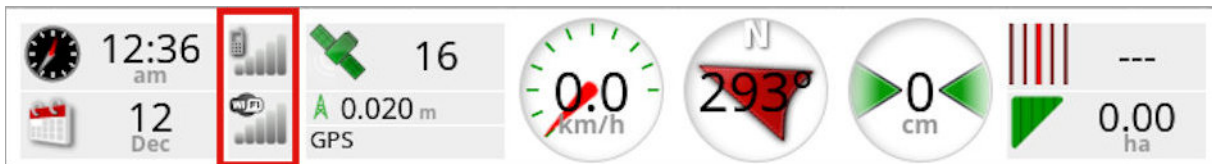

The signal strength panel shows the cellular and wireless signal strength.

GPS and correction source

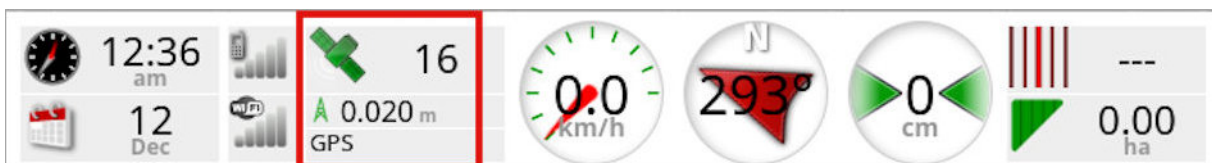

The GPS panel shows:

- System readiness (satellite icon) and the number of satellite signals available.
- Correction quality and position accuracy.
- Correction source in use.

Note: If correction source is set to **Autonomous**, the dashboard displays **GPS**.

Accuracy to within 2 cm is high level accuracy.

Satellite icon

A green satellite icon shows that the GPS and correction source are converged and is based on HDOP. Other colors indicate that information is not available:



Grey: No correction source, no signal



Red: Poor accuracy



Yellow: Average accuracy



Green: Good accuracy

Note: If **AUTOMATIC** was chosen during GPS setup, the colors may shift during operation as different correction sources are detected. If a specific source was chosen during GPS setup, then the system will seek to detect the chosen system. See [Correction sources, page 61](#) for more information on correction sources and [GPS accuracy tab, page 136](#) for more information on HDOP.

Correction icon



Grey: No correction source received.



Red: Correction source received is different from configuration.



Yellow: Correction source received but not accurate enough to engage auto-steering. Check differential correction and position accuracy on steering status.



Green: Correction source has converged for auto steering. (Position accuracy on steering status panel page is green.)

Guidance information

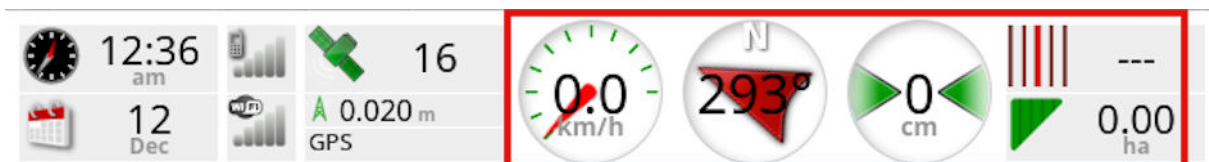

The guidance information panels may be configured to display four of six possible options: cross track error, speed, heading, swath, area worked or area remaining.

- **Cross track error:** Displays the distance of the vehicle from the nearest wayline.
- **Area worked:** Displays the total area of the coverage, per boom (including overlaps).
- **Area remaining:** Area that has not had coverage applied within boundaries that are not excluded from the current task.

The vehicle speed icon will change depending on the vehicle speed source selected in the Setup screen **Implement** / controller / **Speed Source**. If the vehicle speed is displaying incorrectly, calibration of the speed source may be required.

9.8. Recognizing color and working status

The Operation screen uses colors to indicate the status of functions. The exact meanings will vary slightly with the implements, choices and features established during setup.

In general terms:

- Red indicates that the function cannot be used. Check that all necessary items have been enabled and set up correctly.
- White indicates that the function is ready to use.
- Yellow and/or green indicate that the function is currently working.

9.9. Understanding default file names

When new vehicles, implements, guidelines or tasks are created, the system displays a default name that can be changed by the operator.

Vehicles and implements are named as follows:

- <Vehicle Type/Implement Type>_XX

The _XX is appended if an implement of that name already exists (for example: **Pivoted** and **Pivoted_01**).

Tasks are named as follows:

- <Implement Name>_YYYYMMDD_XX

The <Implement Name> is that of the currently loaded implement, followed by the date in the format: Year, Month, Day. The _XX is appended if a task of that name already exists (for example: **Pivoted_20190321** and **Pivoted_20190321_01**).

Guidelines are named as follows:

- <Default_Prefix>_YYYYMMDD_HHMM_XX

The _XX is appended if a file with the same name already exists (for example: **L_20190321_1505** and **L_20190321_1505_01**).

Note: Renaming items in a structured way is recommended. This allows items to be easily identified in later seasons.

When fields and guideline groups are created automatically using the task button (see [Task Button, page 158](#)), they are named as follows:

- YYYY-MM-DD-HH-MM-SS_XX

The _XX is appended if a file with the same name already exists.

These names can be changed via the inventory manager, if required.

Chapter 10 – Steering Calibrations

The display uses the satellite data it receives, through the receiver attached to the top of the vehicle, to identify the precise coordinates of the vehicle. Using this and other data, the system is able to estimate the vehicle's position and control the vehicle's steering system.

For this to work properly, the system needs to be calibrated for the individual vehicle. If the system has not been calibrated for this vehicle, follow the steps in this chapter.



WARNING: Drive the vehicle to a suitable area with level ground, away from people and obstacles, with room to drive in complete circles. To ensure accurate calibration, the vehicle should have open sky visibility and be well away from trees, high voltage power wires and buildings.







It is recommended to remove the implement if it is a trailed, pivoted type implement to avoid implement draw bar interference.

Note: Calibration screens may vary depending on the vehicle selected. Some steering controllers may offer hydraulics calibration.

10.1. Calibrating the compass

Follow the steps to start the calibration wizard. Drive to a place that will not interfere with the calibration before beginning. This should be away from high voltage and large metal objects, with space to drive in complete circles.

Note: Calibration screens may vary depending on the vehicle selected. **ALWAYS READ THE SCREEN PROMPTS CAREFULLY.**

1. Select **Steering Options Menu**  / **Auto Steer Calibration** .
The Steering Calibration screen displays.
2. Select **COMPASS**. If the component reports as calibrated, still complete the calibration procedure if the receiver has not been calibrated on this vehicle.
3. Read the screen and find an appropriate flat place away from high voltage and large metal objects. Then select next .
4. Drive the vehicle in a circle at approximately 75% of full lock, the direction does not matter. Once 1 and ½ turns have been completed, stop and select next.
5. Drive the vehicle straight ahead for approximately 100 m then STOP the vehicle. Select next.
6. The system will begin to save calibration data. Wait until the screen states that the calibration is completed successfully and then confirm .

10.2. Calibrating the wheel angle sensor



Note: Wheel angle sensor calibration should be performed once every 6-12 months.



WARNING: Ensure there is sufficient space for the vehicle to complete the full maneuver before selecting Next. The calibration will take up to 60 seconds in each of these locked modes.



WARNING: Some vehicle models may automatically move the wheels to the required position

1. Select **Steering Options Menu**  / **Auto Steer Calibration**  .
The Steering Calibration screen displays.
2. Select **WHEEL ANGLE SENSOR**. If the component reports as calibrated, still complete the calibration procedure if the receiver has not been calibrated on this vehicle.

Note: The number of screens and contents of screens may vary depending on the vehicle and type of steering controller. If an error displays, read the message and take the recommended action before proceeding.

3. Drive the vehicle forward to start the procedure. The wheel angle sensor calibration should be completed at 2 kph (1.2 mph).
4. Turn the steering wheel full lock to the left and select next  .
5. Turn the steering wheel full lock to the right and select next.
6. Ensure the vehicle is still moving at 2 kph (1.2 mph). Turn the steering wheel as close to the center position as possible.

Note: Finding the center position and driving in a straight line, before selecting Next, is crucial for system performance.



WARNING: Ensure there is sufficient space for the tractor to drive forward in the center position before proceeding.

7. Select next.

10.2. Calibrating the wheel angle sensor

8. The system will begin to save calibration data. Wait until the screen states that the calibration is completed successfully and then confirm .

Note: Some steering controllers may cause the display to offer hydraulics calibration. If this is displayed, select hydraulics and follow the screen prompts.

10.3. Calibrating the mounting bias

Mounting bias refers to the initial offset from horizontal at which the GPS receiver is mounted on the roof of the vehicle. The following things can affect and change the mounting bias:

- Tire pressure
- Track tension
- Duals
- Tire sizing
- Cabin suspension
- Cabin repairs (suspension and mounts)
- Removing and refitting the receiver
- Mounting location has moved

Note: Mounting bias calibration should be performed if any of the above change or at a minimum once every 6-12 months.

It is advisable to still perform a mounting bias calibration when using **Autonomous** as the **Correction Source**, even though the screen reports that it is not required.

Mounting bias calibration is done in a clear area well away from obstacles. If the mounting of the receiver is not quite level, this calibration will adjust for the actual position.



WARNING: Ensure the vehicle has sufficient space to travel in a straight line for at least 70 m/230 ft and then turn at each end of the wayline.

1. Select **Steering Options Menu**  / **Auto Steer Calibration** .

The Steering Calibration screen displays.

2. Select **MOUNTING BIAS**. If the component reports as calibrated, still complete the calibration procedure if the receiver has not been calibrated on this vehicle.

Note: To calibrate for mounting bias, 'A' and 'B' wayline points are plotted over 70 m/230 ft, driving the vehicle at 2 kph or 1.2 mph along the wayline. The operator turns the vehicle around at the end of the pass and repeats the procedure. It is important that the vehicle meets the 'A' and 'B' waypoints within approximately 30 cm, to initiate the next step in the calibration procedure.

3. Reposition the vehicle in an open area. When ready to start the procedure, select  to mark the 'A' waypoint.
4. Drive forward in a straight line. The 'B' waypoint is created automatically when the **Distance To A** indicates 70 m/230 ft.
5. Turn the vehicle around and acquire the wayline just plotted, this track number should read '0'.
6. Select **Auto Steer Engage** on the operations screen to steer on the wayline. The color will turn green, an audible tone will sound and an 'engage message' will flash on screen to indicate the auto steering has engaged.

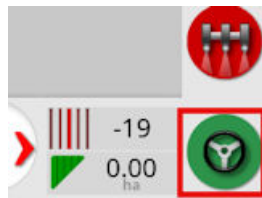

If steering does not engage when **Auto Steer Engage** is selected, the steering status box will appear.

7. Address any of the issues with red indicators before proceeding with the mounting bias calibration procedure (work through issues displayed from the top to the bottom of the screen).

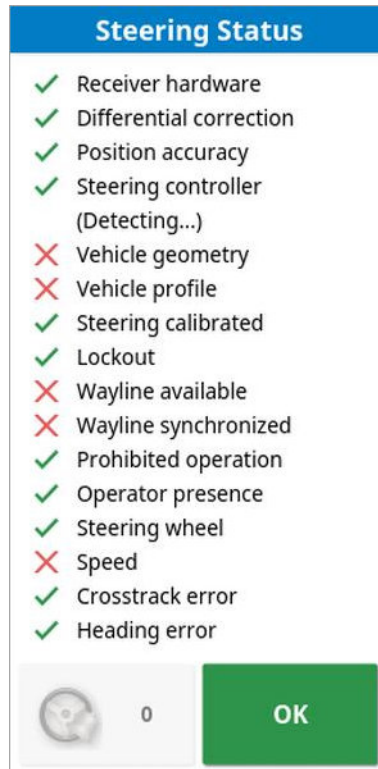

8. Drive the vehicle over the 'B' point previously created during the calibration procedure.
9. Set the vehicle speed to 2 kph or 1.2 mph.
10. Steer along the wayline back to the 'A' point previously created.

When the **Distance To A** indicates 50 m the blue line on the Calibration Progress bar will start to move and the percentage will increase.

When the Calibration Progress bar reaches 50% the calibration bar will stop and the percentage will remain at 50%.

This indicates the system has enough data for the first stage of the calibration and the mounting bias calibration will be paused at this point.

11. Proceed to cross the 'A' waypoint.
12. When the 'A' waypoint has been crossed, turn the vehicle around.
13. Acquire the track '0' and engage the auto steering again.

10.3. Calibrating the mounting bias

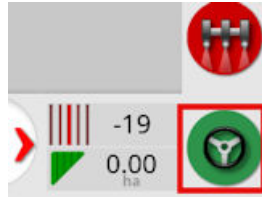

14. Cross over the 'A' waypoint again travelling in the opposite direction.
15. Set the vehicle speed to 2 kph or 1.2 mph.
16. Steer along the wayline back to the 'B' waypoint previously created.

When the **Distance To B** is less than 50 m, the blue line on the Calibration Progress bar will move from 50% and the percentage will increase.

When the Calibration Progress bar reaches 100% this indicates the system has enough data for the second stage of the calibration and the mounting bias calibration is paused at this point.

17. Proceed to cross the 'B' waypoint.
18. Stop the vehicle. Mounting Bias has been successfully calibrated.
19. Confirm **OK** to return to the calibration screen.

The Steering Calibration screen will display **Calibrated** for Compass, Wheel Angle Sensor and Mounting Bias.

20. Confirm **OK** to return.

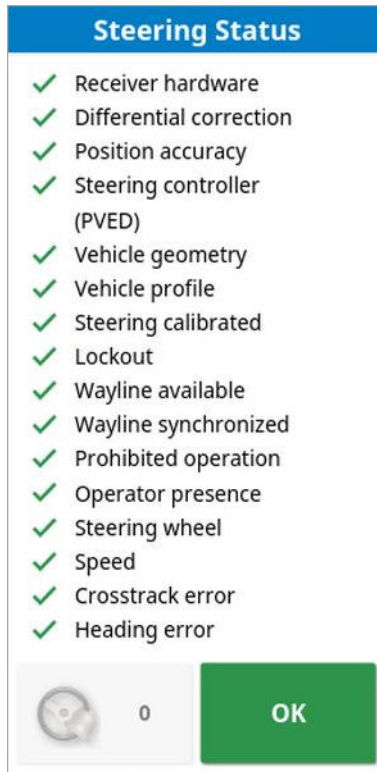

Steering Status box indicators will now all be green.

10.4. Dealing with calibration errors/alarms

The following errors / alarms can occur during calibrations. Perform the recommended procedures below to fix the errors.

Steering controller not initialized

The steering subsystem is not turned on or is not ready for use.

Check to see that the steering subsystem is powered on and ready for use.

Steering profile mismatch

The parameters in the selected vehicle profile do not match the vehicle configuration in the steering subsystem.

Select the correct vehicle profile for this vehicle.

Parameters mismatch

Vehicle geometry parameters do not match the geometry configuration in the steering system.

Re-select the vehicle on the Setup screen or ensure the vehicle geometry in the vehicle geometry screen is correct.

Receiver disconnected

The AGI receiver has shutdown, lost power or the receiver – display serial connection has been broken.

Check the power supply to the receiver and ensure the serial connection is good.

Compass calibration failed

Repeat compass calibration and ensure the vehicle completes 1½ turns. Ensure the vehicle is stopped when completing the procedure.

Move the receiver away from magnetic sources.

Wheel angle sensor calibration failed

Repeat procedure and ensure the steering axle moves through the complete range.

Confirm wheel angle sensor position information moves when steering axle is turned.

Confirm wheel angle sensor harnesses and connections. Check wheel sensor condition.

Failed wheel angle sensor.

Receiver firmware version is out of date

Update receiver firmware.

Chapter 11 – Task Button

The task button at the top of the guidance toolbar  must be pressed to start a task.

Depending on what state the system is in, the appearance of the task button will vary:

 Preconditions to start a task are not satisfied. Press to display errors preventing a task from running.

 A task is ready to be started. (The task already exists.)

 A task can be started. Starting a task will first create a task (and possibly a field).

 A task is running and actively recording data.

 The task is paused. Press the button to resume the task.

 The task is completed.

Note: If the task is not running, there will be no coverage on the map or in the task report and auto section control and rate control will not be available.

Pressing the task button also enables the user to quickly start work without having to set up a client, farm, field, task etc.

Note: If a field is already set up in the current GPS location, that field is automatically loaded.

Pressing the button starts a task, and may also create a field if one is not already loaded. A message pops up for five seconds that displays which functions have been performed automatically.

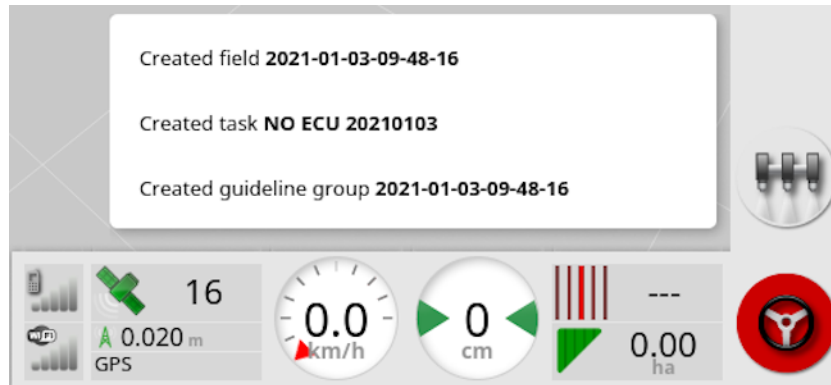

If a field is created by starting a task, the perimeter of the field is determined by the task boundary when the task is completed (created by coverage laid). Be aware that if the whole field is not covered by the task that the task boundary won't match the real physical perimeter of the field. This may also result in a second field being created if another task is started at the opposite end of the field as the system has no way of knowing the two fields are physically linked. The boundary from coverage function (see [Creating a boundary from coverage, page 170](#)) can be used to change the task boundary into a real boundary, if required. (The task that was used to lay the coverage must be selected.) Alternatively a new boundary can be recorded.

Note: Task boundaries cannot be used to display headlands or perform headland turns.

The Task Settings tab on the Task Information screen (see [Viewing task information, page 140](#)) displays the names of the automatically generated functions. These may be edited using the inventory manager (see [Inventory Manager, page 248](#)).

Pausing a task

The user should pause the task whenever they need to leave the field to do operations like refill the tank. Press  to display the following screen, then select **Pause**.

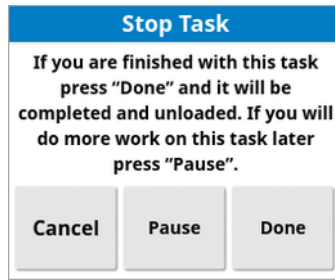

Press the  button to resume the task after returning to the field.

Completing a task

Press , then select **Done**.

Once the task is completed, it is put into the stopped state and the task is archived along with its dependencies (e.g. field boundaries, products, guidelines that were used in the task). The task will be exported to TAP, if enabled.

If a task is stopped in error, it can be reloaded and restarted, see [Selecting an existing task, page 178](#). A warning is displayed that must be accepted before the task can be restarted.

Chapter 12 – Field Menu

This chapter details how to set client, farm, field, boundaries, exclusion zones and flag points.

The display will store the field information so that, once set up, the field details can be recalled for other tasks in the same field.

Drive to the field and follow the steps to set up a field and identify its features.

Note: The vehicle must be in or near the field for boundaries and related information to appear on the screen.

12.1. Selecting a field

Driving into a field (when there is no field selected or task in progress), or turning on the Topcon display while located within a field, automatically loads that field.

If a field has been previously selected or a task is in progress, a message displays when entering a new field, providing the option to select the field.

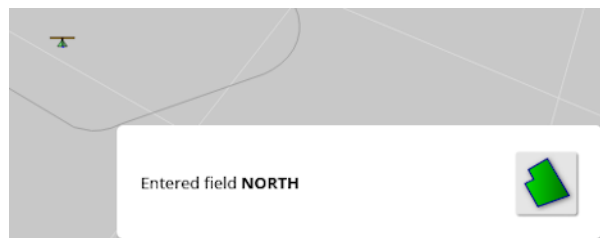

To manually select a field:

1. Press and hold on the screen and drag your finger over the required field boundary.

The select field pop up displays.

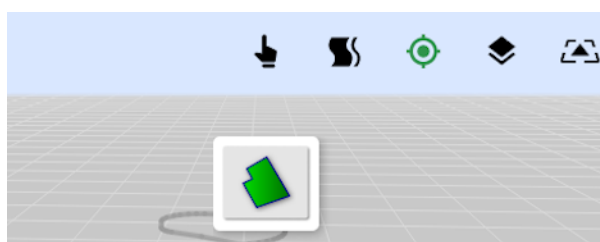

12.1. Selecting a field

2. Select the pop up to activate the field.

Alternatively:

1. Select **Field Menu**  / **Select Field** .

The fields displayed can be filtered. A maximum of four filter criteria can be selected at one time.

2. Select  to display the filter options.

Press and hold on a field to display detailed information about that field.

The displayed fields can be sorted by name or distance by selecting

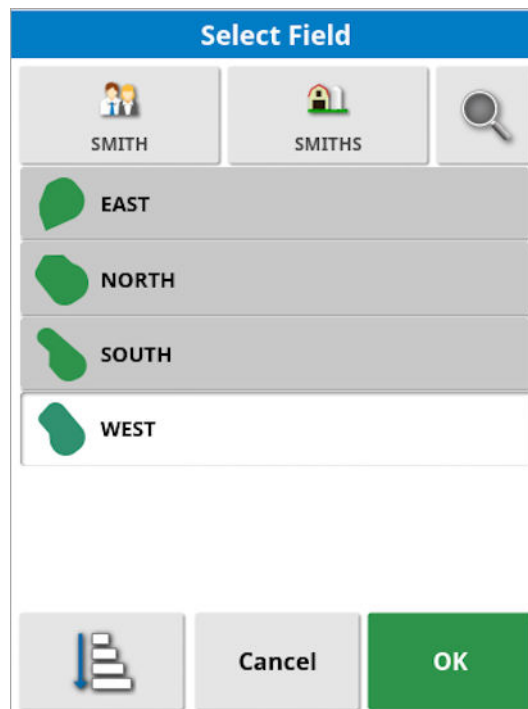

3. Select the required field and confirm.

12.2. Creating a field

1. Select **Field Menu**  / **New Field**  .

Note: Default file names are provided when naming options appear. It is highly recommended that the operator names items in a thoughtful and structured way to allow easy use in future seasons.

Note: A field can be created without associating it with a client or farm, if required. Once you create a client and /or farm, that will be associated with all the fields you create until you switch to a field that is in a different farm.

2. Select **CLIENT NAME**, select **New**, enter a name and confirm (or select an existing client if some have already been set up).

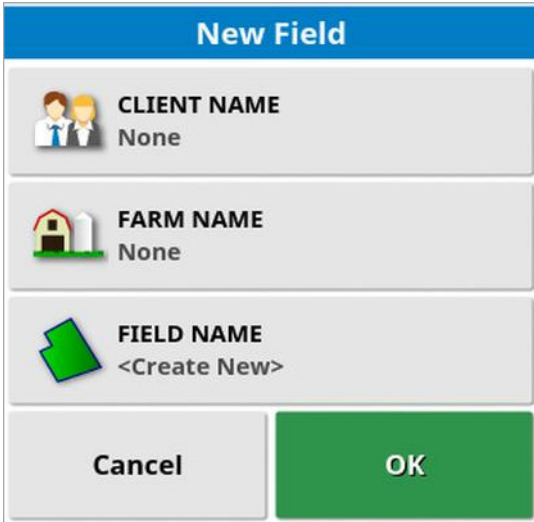

3. Select **FARM NAME**, enter a name and confirm (or select an existing farm name if some have already been set up).
4. Select **FIELD NAME**, enter a name and confirm.
5. Completing this section selects the new field, proceed to [Setting a new boundary, page 168](#).

Note: To change any of these settings after they have been confirmed, see [Inventory Manager, page 248](#).

12.3. Unloading a field

The Unload field option  may be used to exit from a field and its associated flag points, boundaries etc. This prevents new coverage being added to the field if the vehicle has been moved to a new field but the operator has neglected to create a new field / task.

If this option is not used, when the vehicle has moved more than 15 km away from the current field, the following message is displayed, and the field is unloaded automatically "The active field is more than 15 km away and has been deactivated and its data unloaded."

Note: The display will no longer restart when it has travelled too far from the current field.

12.4. Setting flag points

Flag points are used on the guidance map to indicate obstacles and noted items in the field.

Note: If required, flag points can be used with an exclusion zone around the obstacle (such as a large hole or electrical tower). If this is needed, read this section and read [Editing a boundary, page 172](#).

1. Drive to the item to be flagged.

2. Select **Field Menu**  / **Set Flag Point**  .

3. To flag the obstacle, choose a flag symbol to be placed at that spot on the map.



Note: To change Flag Point presets, see [Setting up flag points, page 81](#).

4. To customize flag points, select **Custom** to define a particular flag point.

12.4. Setting flag points

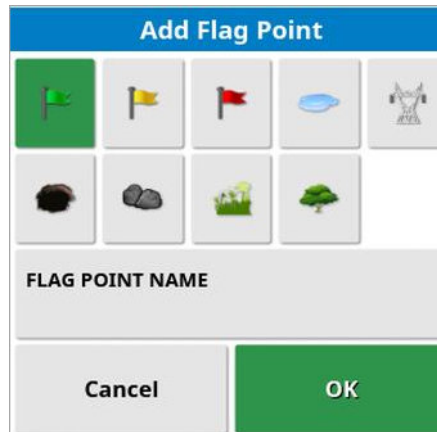

5. Select the required symbol, select **FLAG POINT NAME** and enter the name. Confirm the name. Confirm to add the customized flag point.
6. If an exclusion zone is needed around the obstacle, go to [Editing a boundary, page 172](#).
7. If an exclusion zone is not needed, drive to the next item in the field to be flagged and repeat.

12.4.1. Working with flag points

1. Press and hold the flag point marker on the screen for 0.5 seconds. A pop up displays:

Edit 

Edit flag point settings.

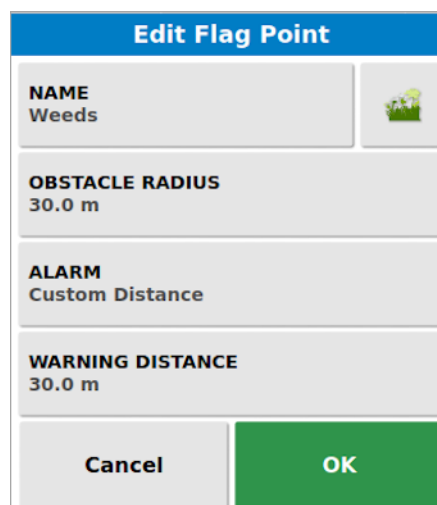

- **Name:** Edit the name of the flag point or change the icon shown.
- **Obstacle radius:** Enter a radius that is displayed around the flag point.
- **Alarm:** Turn flag point alarm on/off and select the default or a custom trigger distance. (This overrides the **Flag Point Nearby** setting in general alarms, see [Setting up alarms, page 70.](#)) This setting is not visible if the alarm is disabled in general alarms.
- **Warning distance:** Enter a custom distance at which the flag point alarm is triggered. This is measured from the edge of the Obstacle Radius. (This overrides the **Flag Point Nearby** setting in general alarms, see [Setting up alarms, page 70.](#))

Change flag location



Move the flag point by pressing and dragging to a new location.

GPS drift correction



Move the vehicle to the flag point location to compensate for GPS drift.

Note: To remove applied GPS drift compensation, see [Compensating for GPS drift, page 231.](#)

Delete



Remove the selected flag point.

12.5. Setting a new boundary

Setting the boundary establishes the perimeter of the field (or a section of a field). Boundaries may overlap.

If required, it is possible to create multiple boundaries within a field. They may be created by driving around the boundary (see below), created from coverage (see [Creating a boundary from coverage, page 170](#)) or created from shapefiles (see [Creating a boundary from a shapefile, page 171](#)).

Note: If a boundary is not recorded for a field by the operator, then when a task is completed a task boundary is created around the perimeter of the task. Task Boundaries are used to detect the field the next time the vehicle returns to the field and to group tasks and guidelines (if they've been created) by that GPS location, to allow easy access to that data in the future.



Be aware that if the whole field is not covered by the task that the task boundary won't match the real physical perimeter of the field. This may also result in a second field being created if another task is started at the opposite end of the field, as the system has no way of knowing the two fields are physically linked. The boundary from coverage function (see [Creating a boundary from coverage, page 170](#)) can be used to change the task boundary into a real boundary, if required. Alternatively a new boundary can be recorded.





The interior of a created boundary defaults to a work region, however, any boundaries created within that boundary default to an excluded region (shown as greyed out). These properties may be edited. See [Editing a boundary, page 172](#).

A boundary recording offset may be specified to control where the boundary is recorded in relation to the vehicle. This accounts for fences and other obstacles that do not allow the vehicle to drive exactly on the boundary.

Once the offset is entered, the vehicle must be driven around the boundary of the field.

1. Drive the vehicle to the edge of the field.

2. Select **Field Menu**  / **Boundary Offset** .

Boundary Offset	
	RECORDING OFFSET Right
	ADDITIONAL OFFSET 0.000 m
	RECORDING POSITION Implement Front
	ADDITIONAL FRONT OFFSET 0.000 m
Cancel	OK

- **Recording Offset:** Positions the offset on the left or right side of the implement.
- **Additional Offset:** Enter a positive value to extend the offset beyond the edge of the implement. A negative value positions the offset within the implement extents.
- **Recording Position:** Select to record the boundary from the front or rear of the implement, or from the position of the vehicle.
- **Additional Front Offset:** Moves the recording position forward (or back if a negative value is entered).

Note: An implement needs to have been established during setup, but the actual implement does not need to be physically attached to the vehicle.

3. Select **Record Field Boundary** .

4. Drive the vehicle around the boundary of the field. A blue line will display the boundary being recorded, taking into account any offset.

12.5. Setting a new boundary

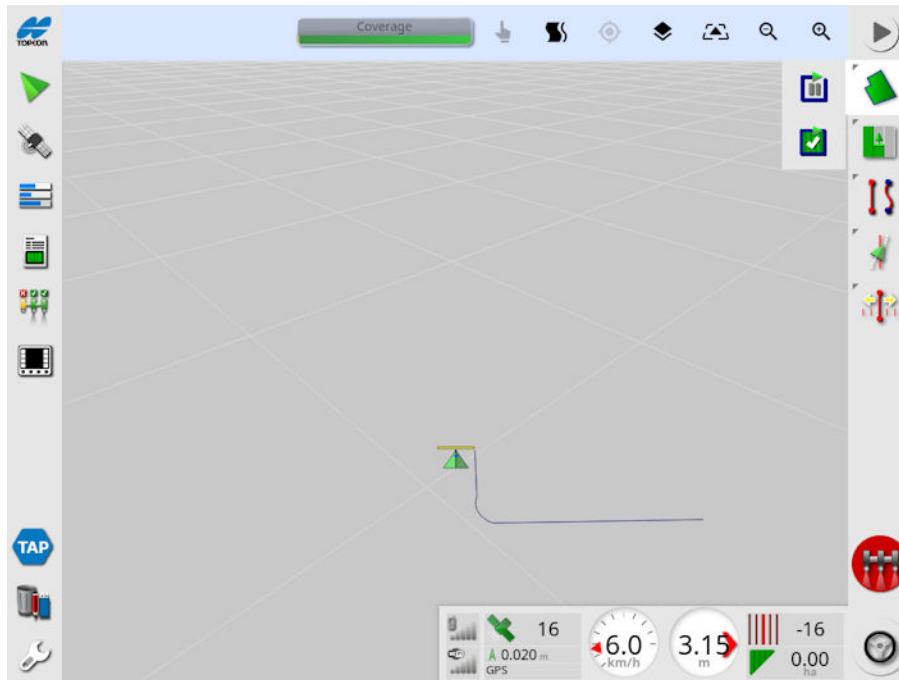

5. Select **Pause**  to pause recording. This is useful if an obstacle prevents driving on the boundary. The icon will change to show the

record option. Select **Record**  to resume. The boundary will record a straight line between the point at which recording was paused and the point at which recording was resumed. Note that boundary recording may be automatically paused if the master switch is turned off (see [Pause boundary recording with master](#), [page 35](#)).

6. As the vehicle approaches the start point, select **Complete Field**

Boundary Recording  to automatically complete the boundary.

7. Repeat the procedure for more boundaries, if required.

12.5.1. Creating a boundary from coverage

A boundary may be created from existing coverage.

1. Select **Field Menu**  / **Create Boundary from Coverage**  to display the Boundary from coverage settings panel.

- **Smoothing:** The minimum gap size that will be automatically filled when creating a boundary from coverage.
- **Minimum coverage area:** Any coverage smaller than the area specified here will not automatically create a boundary.
- **Distance from coverage:** Expands the created boundary the specified distance from the coverage.
- **Excluded Regions (on / off):** Excluded regions are used to indicate areas that will not have product applied if section control is being used. Turning this on will automatically create excluded regions from any gaps in coverage that are within the total coverage area.
- **Minimum excluded area:** Any gap in coverage smaller than the area specified here will not automatically create an excluded region. This prevents very small gaps in coverage inside the boundary from automatically being created as excluded regions.

A boundary (or multiple boundaries) is drawn around the outside edge of existing coverage. New boundaries are added to the current field.

12.5.2. Creating a boundary from a shapefile

A boundary may be imported from a shapefile stored on a USB or from TAP.

1. Load the shapefile onto a USB (if using) and insert the USB into the display. (Alternatively, ensure the display is connected to TAP.)

2. Select **Field Menu**  / **Create Boundary from Shapefile**  .

3. Select the USB or TAP icon at the base of the screen.
4. Navigate to the location where the shapefile is stored and select it.
5. Confirm to import the shapefile boundary.

12.5.3. Editing a boundary

Once a boundary has been created, it can be edited.

1. Press the screen for 0.5 seconds and slide your finger across the boundary. The boundary is highlighted and a pop up displays when the screen is released:

 Activate boundary steering. See [Using boundary steering, page 196](#). Select **Guidelines Menu / Change Guidance Mode** if this option is selected by accident.

 Select to display the Edit Boundary screen.

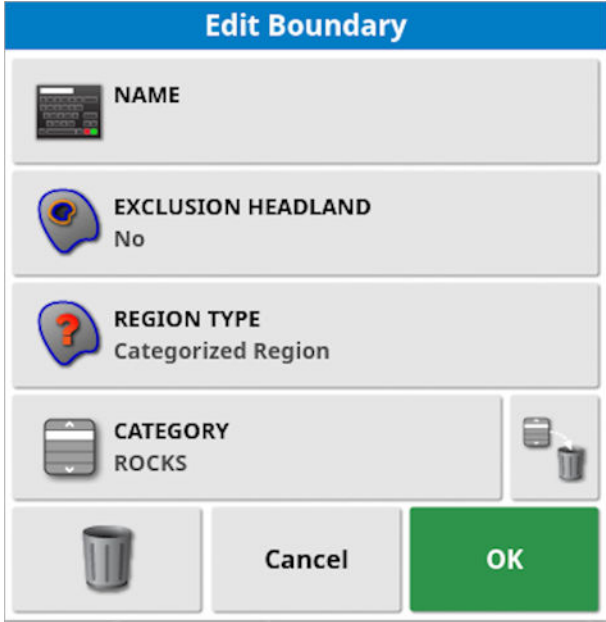

- **Name:** Optional name used to identify the boundary.
- **Exclusion Headland:** Sets whether the exclusion zone boundary edges will be treated as a headland (see [Setting up a working headland, page 174](#)).
- **Region Type:**
 - **Work Region:** Work regions are used to indicate areas that will have product applied if section control is being used.
 - **Excluded Region:** Excluded regions are used to indicate areas that will not have product applied if section control is being used.

- **Disabled:** The existence of the boundary is ignored.
- **Categorized Region:** Where there are a large number of boundaries, assigning each a category may be useful (for example, to include areas while spraying, but exclude those areas while seeding). Categories may then be used to define work regions and excluded regions for the current task (see [Configuring task regions, page 180](#)).
- **Category:** Used to assign or create region categories. Only shown if Categorized Region is selected for Region Type. (The bin button next to this field can be used to delete unused categories.)

The bin button at the base of the screen can be used to delete the selected boundary.

12.5.4. Removing a boundary

If a boundary must be changed, it can be erased and a new boundary can be set. To delete a single boundary, the bin button on the Edit Boundary screen can be used.

To delete all boundaries in a field:

1. Drive to the field.

2. Select **Field Menu**  / **Select Field**  to choose the client, farm and field names. The boundary will appear on the screen.

3. To remove the boundary, select **Clear Boundary** . A message will ask for confirmation.

Note: Erasing boundaries is a permanent action.

12.6. Setting up a working headland

Implements often work around the boundary differently from the rest of the field. A headland creates a zone inside the line of the boundary that will be worked differently. The width will depend on the operator's method of working the field.

Note: Headland data is stored with the selected implement. This allows each implement to have different headland requirements.

Note: A headland can only be created once a boundary has been recorded, see [Setting a new boundary, page 168](#).

Follow the steps to set up the working headland for this implement inside the field boundary.

1. Select **Field Menu**  / **Configure headland for this implement**



Headland Options
HEADLAND Enabled
HEADLAND WIDTH (SWATHS) 0.0
HEADLAND OFFSET 0.0 m
LOOK AHEAD 10 m
Configure actions
OK

2. Ensure **Headland** is enabled.

The width of the headland can be defined using **Headland Width** or **Headland Offset**. If both are used, the two figures are added together for the total headland width.

3. Select **Headland Width (Swaths)** and enter the width of the headland in swaths from the inside of the boundary, then confirm. A swath is the working width of the implement.

Note: To set a headland width that is not related to the swath width, use **Headland Offset** to enter a value instead.

4. To increase the width of the headland, if needed, select **Headland Offset**.

This may be useful to supply a buffer zone for steering if the headland width has been set so that the tip of the implement would be touching the fence.

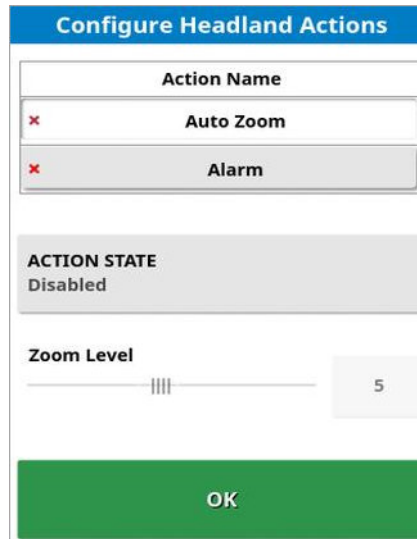

If you have recorded the field boundary so that the blue line is on top of the fence line (the actual physical boundary of the field), then set a headland of 1 swath, you would be required to drive with the tip of the implement touching the fence to fill this area with no overlap. Obviously this is not a particularly useful scenario. So in this situation you can add an offset of 1 meter (for example) to your headland, which will move the headland an extra 1 meter inside the boundary, allowing you to have a 1 meter gap between the implement and the fence.

5. Enter the offset measurement and confirm.
6. Select **Look Ahead**. This sets how many meters in front of the vehicle that the system looks to respond with actions.
7. Enter the distance in front of the vehicle for actions and confirm.
8. Select **Configure actions**.



Action Name

- **Alarm:** Sets an alarm to trigger when approaching the headland.
- **Auto Zoom:** If this is enabled, the map view will zoom in or out to the defined zoom level as the vehicle approaches the headland and return to the original defined zoom level as the vehicle leaves the headland. Select the preferred zoom level.

Note: When an action is enabled it is marked with a . When an action is disabled it is marked with a .

Action state

Allows the map view to zoom in when approaching the headland.

Message

Enter the words for a visual message (for example 'Approaching headland'). Enter the text and confirm.

Audio type

Sets an audible alarm. Choose the type and confirm.

9. Confirm the alarm and zoom actions. The screen can now display a headland in orange inside the boundary line.

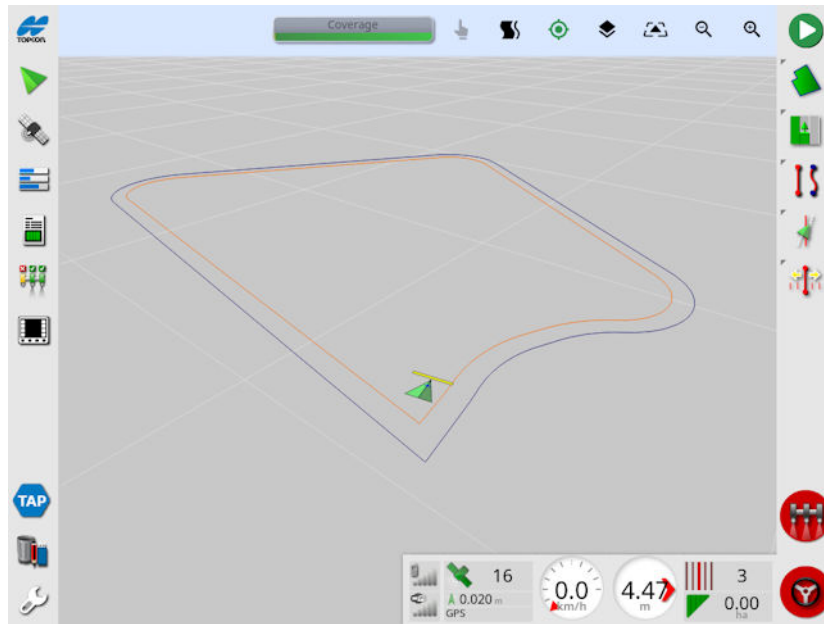

Approaching the headland will trigger the alarm and zoom that has been set.

Chapter 13 – Task Menu

The Task Menu selects or sets up specific task information associated with the chosen field. Using this menu, the task information is stored and activity can be recorded and reported.

Note: Tasks were previously referred to as jobs in Horizon. All data that was previously in a Topcon proprietary format is now stored in TaskData XML format as per the ISOBUS 11783-10 standard. This is the most widely used standard in the industry and allows data to be processed by third party systems such as Farm Management Information Systems.

13.1. Selecting an existing task

Task information can be recorded, stored and transferred for later access.

Drive to the field and follow the steps to choose an existing task. To create a new task, see [Creating a new task, page 179](#).

1. Select **Task Menu**  / **Select Task** .

The tasks displayed can be filtered. A maximum of four filter criteria can be selected at one time.

2. Select  to display the filter options.

Note: When filtering by implement , this displays a list of implements associated with the tasks on the system, not a list of the implement profiles on this console.

Press and hold on a task to display detailed information about that task.

The displayed tasks can be sorted by name, distance, age or date

by selecting .

3. Select the task and confirm.

13.2. Creating a new task

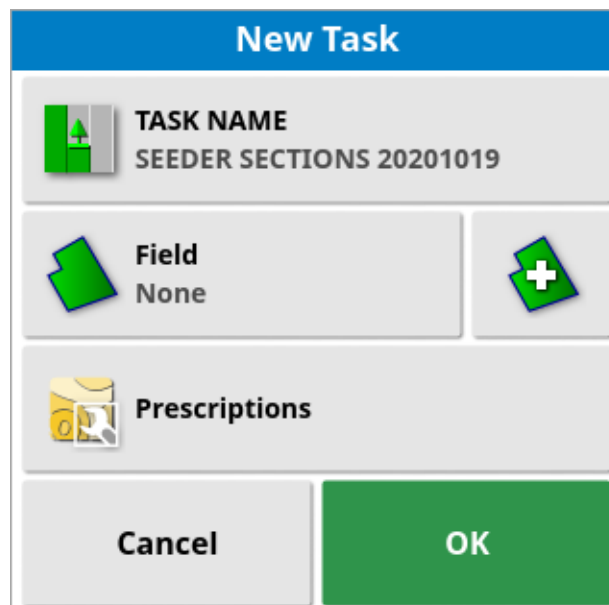

Creating a task while located in a field assigns the task to that field. However, if required, a different existing field can be selected or a new field manually created from this screen. (This may be useful if planning work in other fields.)

1. To set up a new task, select **Task Menu**  / **Create New Task**

New Task

 **TASK NAME**
SEEDER SECTIONS 20201019

 **Field**
None 

 **Prescriptions**

Cancel **OK**

2. Select **TASK NAME**.
3. Enter a name and confirm.

Note: Default file names are provided when naming options appear. It is highly recommended that the operator names items in a thoughtful and structured way to allow easy use in future seasons.

If VRC is enabled, the **Prescriptions** option displays. This can be used to configure a task prescription. See [Configuring variable rate control, page 183](#).

4. Confirm the new task.

13.3. Configuring task regions

If one or more boundaries in the current field have a named Category (see [Editing a boundary, page 172](#)), and a task is active, region types for the current task can be selected.

Note: All categorized regions that are not specified in work regions or excluded regions are treated as though that boundary does not exist for this task.

1. To set up a task region, select **Task Menu**  / **Configure Task**

Regions  .

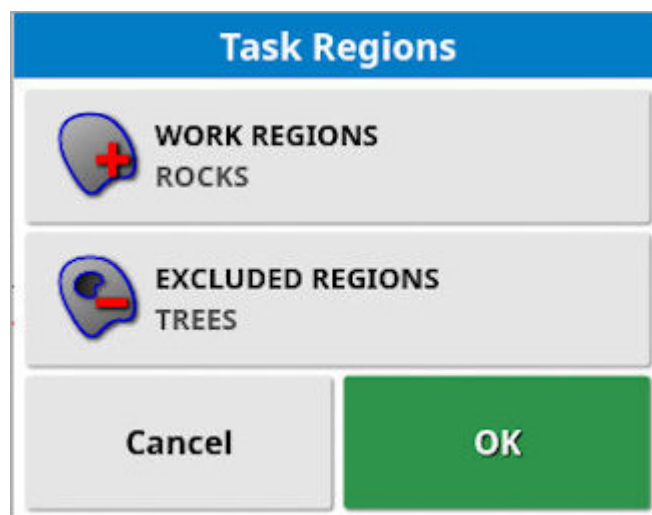

- **Work Regions:** The boundary contents are included in the work area of this task.
 - **Excluded Regions:** The boundary contents are excluded from the work area of this task.
2. Select the region types to be included and excluded for the current task.

Note: Areas that will be treated are shown as a lighter grey area on the map (if auto section control is enabled and the Boundary Limit is not set to Unlimited).

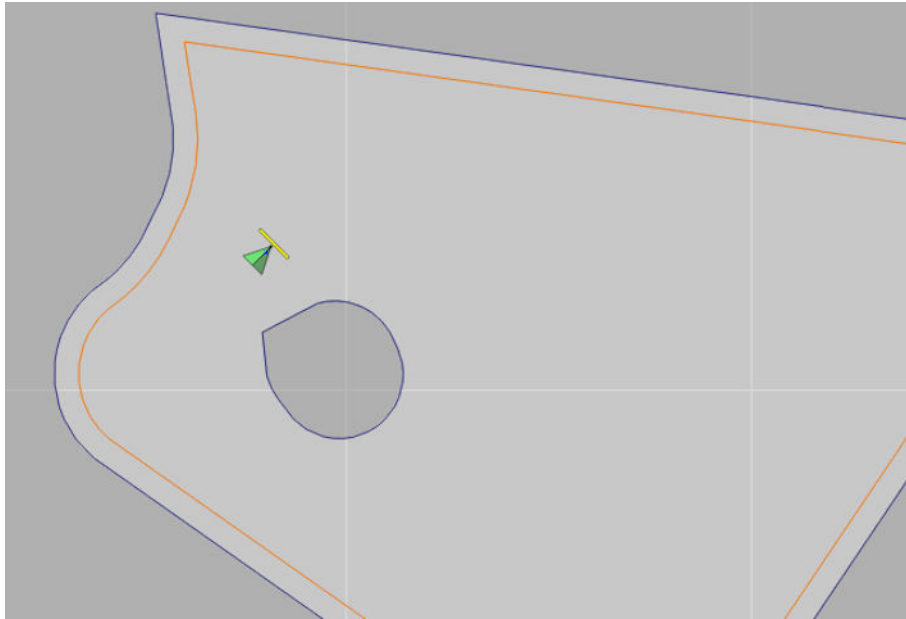

13.4. Clearing a task

This action will remove any coverage information on the screen and delete task data that has been recorded on the current task. It does not affect field information or guidelines set for the field.

1. Select **Task Menu**  / **Clear Task**  .

The following message appears.

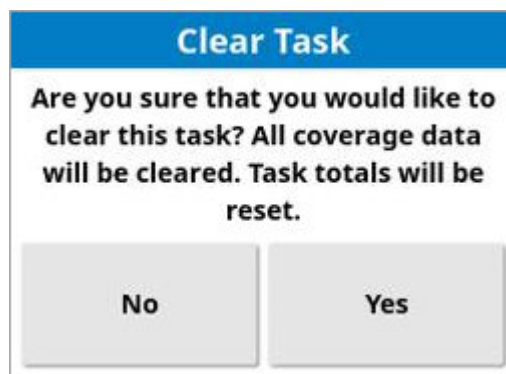

2. Select **Yes** to clear the data or **No** to keep the data.

To delete farms or fields or previously created task data, see [Inventory Manager, page 248](#).

13.5. Configuring variable rate control

Before use, Variable Rate Control (VRC) must be set up with a controller and must be enabled on the Setup screen (**System / Features / Implement**).

Select  to enable or disable the VRC Map display on the guidance screen.



Product application rates that can be controlled by the display are automatically added to the list of available targets. If the ECU has support for control targets that have not been automatically added to the list, e.g. pump or fan speed, these can also be added to the list of control targets. To do this, press the  button and then select the desired target from the list of available targets that is shown. The rate control of this target can then be configured in the same way as any of the other targets in the list.

1. Select or create a task.

2. Select **Task Menu**  / **Configure Task Prescriptions** .

Note: Task prescriptions may also be configured via the **New Task** screen. See [Creating a new task, page 179](#).

Task Prescriptions			
Target	Source	Attribute	Unit
(1) TC Test Bin 1:1 Setpoint Rate	None		L/ha
(2) TC Test Bin 2:1 Setpoint Rate	None		L/ha

- **Target:** The tank or bin that is being controlled. Select  to add another target.

- **Source:** The rate source for the target:
 - **None:** No rate control for this target.
 - **Fixed:** Fixed values for Default, Out of Field, and Position Lost.
 - **Task prescription:** Use a grid based prescription map associated with the selected task, created on external software.
 - **Shapefile:** Import a shapefile (.shp) from USB or TAP, or select from shapefiles stored on the display.
 - **Peer control:** Control the target based on a value from a different ECU, for example a nitrogen sensor (CropSpec).
- **Attribute:** The rate source (task prescription, shapefile or fixed source) may have multiple attributes to define the rates for more than one target. This enables the operator to map the prescription to the appropriate target.
- **Unit:** The units the shapefile is using.
-  **Prefill:** If the previous task contained prescriptions, use this button to prefill this task with the prescription settings used in the previous task. Fixed and Peer control rate source carry over with no changes, but Shapefiles become fixed value.

13.5.1. Source options

Fixed source

If **Fixed** is selected as the **Source**, the following screen displays.

Fixed Value		
DEFAULT 0.0 kg/ha	POSITION LOST 0.0 kg/ha	OUT OF FIELD 0.0 kg/ha
Cancel		OK

- **Default:** The default rate to be applied.
- **Position lost:** Rate to be applied if the GPS position is lost.
- **Out of field:** Rate to be applied if the implement moves beyond the field boundary.

Task prescription source

Tasks may be created on an external system with associated prescriptions configured in a grid format. These tasks can be imported from USB via the inventory manager (see [Importing tasks from a USB, page 257](#)). If the selected task has a prescription associated, this option may be used to apply it to a target.

Task data may also be imported via TAP. See [Importing a task data selection from TAP, page 258](#).

Shapefile source

If **Shapefile** is selected as the **Source**:

1. If required, insert a USB with prescription maps or ensure the display is connected to TAP.

2. Select USB , TAP  or the console  as the shapefile source.

3. Navigate to and select the required shapefile (.shp) to be imported.

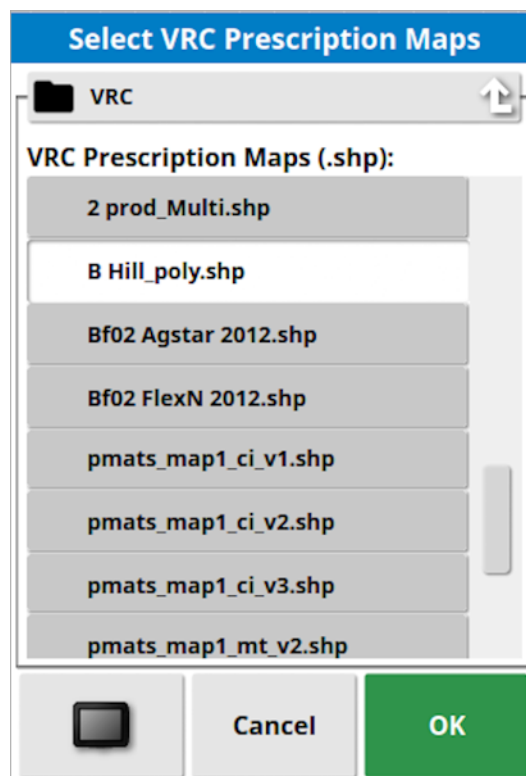

13.5. Configuring variable rate control

Once the shapefile is selected and imported the following screen is shown.

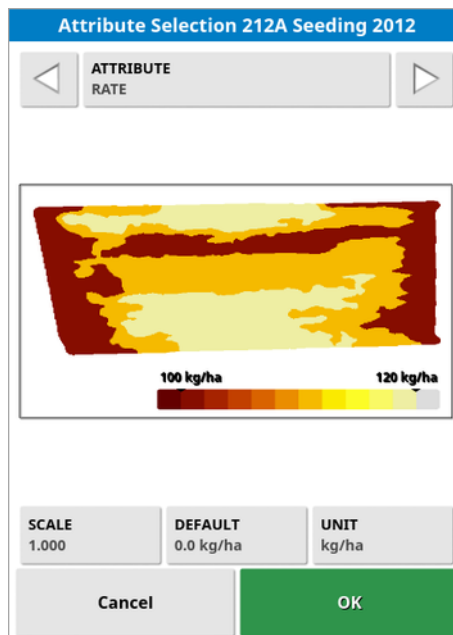

- **Attribute:** Select which attribute from the shapefile you want to use.
- **Scale:** This defaults to 1, which means that the prescription defined in the source will be used directly. However, depending on weather conditions, the operator may choose to increase or decrease the rate of application. This allows a uniform increase for all defined rates. For example, a scale of 1.1 will apply 110% of the rate defined in the source.
- **Default:** Defines the rate to use if the source doesn't specify a rate for that region of the field.
- **Unit:** Select the unit the shapefile is in from a drop-down list. If the display is using a different unit, a scaling factor is applied to change the shapefile values to that being used by the display. This enables a user whose display is in metric, for example, to use a shapefile that is in gallons/acre instead of litres/hectare.

Chapter 14 – Guideline Menu

Guidelines are used to indicate the path that the vehicle should travel for optimum coverage. The system will use the implement width to set evenly spaced lines across the field.

The number of guidelines displayed per field is limited to 20, unless Controlled Traffic is enabled. See [Guidance setup, page 50](#).

If some guideline functions are not required, they can be disabled. See [Guidance setup, page 50](#).

Pressing to select a guideline from the map opens a popup window which allows you to:



Activate / deactivate this guideline for steering and wayline generation.



Edit guideline name.



Toggle propagation. Standard guidelines are propagated (repeated) across the entire field at spacing equivalent to the implement width, with the active wayline at any time being the one closest to the vehicle's current position. In certain special cases propagation is not desired and can be turned off when the loaded guideline should only be followed on swath zero (for example when importing a guideline that represents the complete path for traversing the whole field). If propagation is

on, the icon changes .



Delete guideline.

Note: Guidelines may be edited by selecting the **Guidelines** category in the inventory manager. See [Inventory Manager, page 248](#).

Guideline types



Parallel AB Line guidelines, [page 190](#)



Identical Curve guidelines, [page 193](#)



Manual AB lines, [page 191](#)



Centre Pivot guidelines, [page 194](#)



Project lines, [page 198](#)



Guidelock Guidance mode, [page 195](#)



Boundary Steering Guidance mode, [page 196](#)

Note: Use the Cycle guidance mode button  to cycle through guideline, guidelock and boundary steering modes (available if boundary steering is enabled).

14.1. Selecting an existing guideline



Once guidelines have been created within fields, these are stored and can be accessed on future tasks in the field.

To change between guidelines, press the guideline on the map and

select  to activate the line. Alternatively, you can toggle the active

line using the **Cycle Guidelines** button , an AUX-N input device (see [Auxiliary control setup, page 85](#)) or a VDC (see [VDC setup, page 57](#)).

The **Select Guideline** option can also be used:

1. From the **Guidelines Menu** , select the required guideline mode, then select **Select Guideline** .

All guidelines in the current field are displayed.

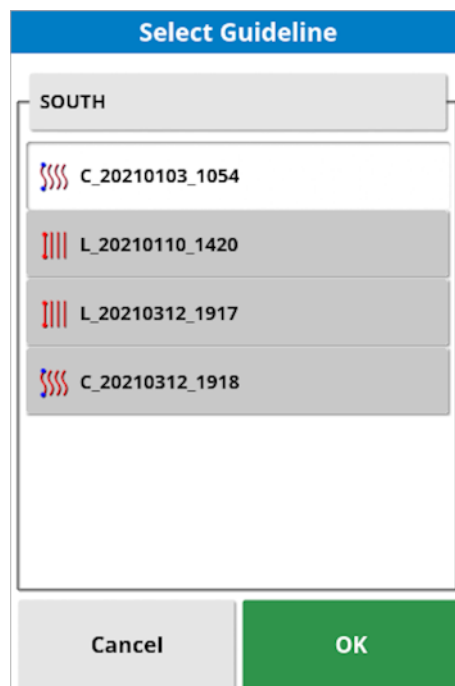

2. Select the required guideline and confirm.

14.2. Using straight lines guidelines

This option creates parallel lines for guidance, using the width of the implement to set the distance between guidelines.

Where working is generally done in straight lines, the AB line should be set near the headland line. This allows the lines to evenly space across the working area.

1. Select **Guideline Menu**  / **Create Guideline**  / **Record AB Line**



2. Position the vehicle at the start of the swath and select **Set A point**





3. To set a 'B' point, drive along the required swath and select

Complete AB Line .

An option to activate (select) the new guideline is shown, if another line has already been activated. The 'B' point appears and parallel guidelines for steering display on the screen.

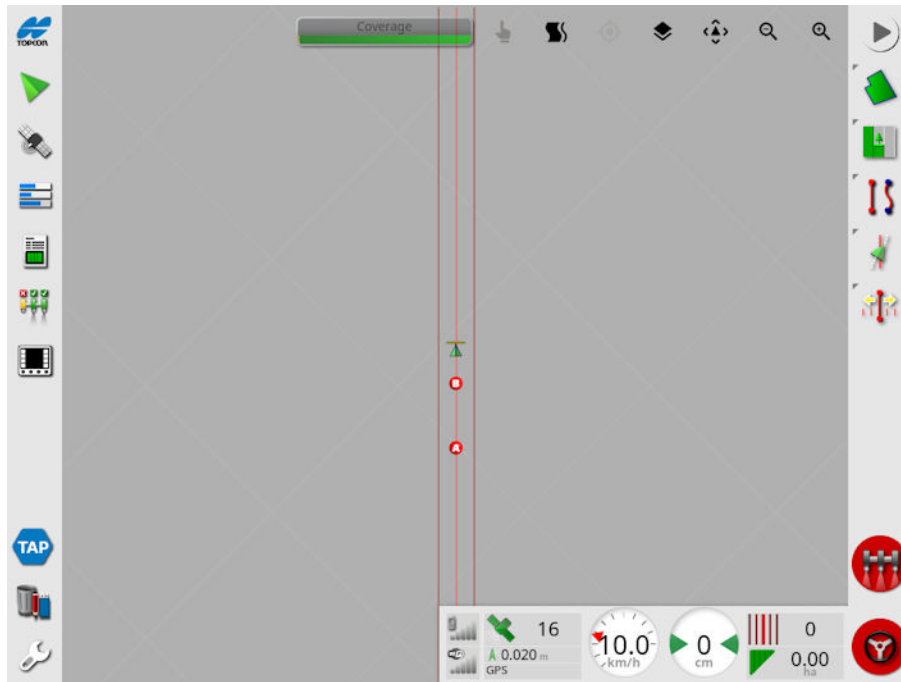
An option to rename the new guideline is also displayed.



To view all AB lines across the field, select  from the top of the screen and choose **Line Numbers**. (This requires a field boundary, see [Setting a new boundary, page 168](#).)

14.2.1. Setting AB lines manually

It is also possible to set AB lines using coordinates.

1. Select **Guidelines Menu**  / **Create Guideline**  / **Record AB**

Line   / **Manual AB Line** .

The Manual AB Line screen displays.

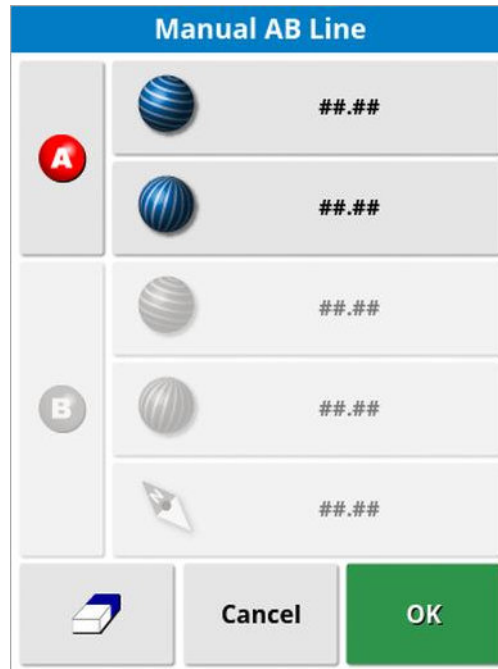

2. Set the 'A' point using one of the following methods:

- Drive to the desired location and select .
- Enter the coordinates (latitude/longitude) of the 'A' point.

3. Set the B point using one of the following methods:

- Drive to the desired location and select .
- Enter the coordinates (latitude/longitude) of the B point.
- Enter the Heading of the AB Line. The software will automatically place a 'B' point to create an AB line of the desired heading, relative to the 'A' point.

Note: To erase a guideline, select .

14.3. Using identical curve guidelines

Some fields are not rectangular and have a curved or shaped boundary. For these, identical curves may be the best option for guidelines. This can be useful for steering the boundary of a field and using this guideline for future operations.

Identical curves allows the operator to set a curved guideline and the system will create equidistant guidelines across the field, based on a swath width.

1. Select **Guideline Menu**  / **Create Guideline**  / **Record Identical**

Curve .

2. Position the vehicle at the start point of the curve and select **Set A**

Point .

3. Drive along the curved swath. A black line appears behind the vehicle on the map to indicate the curve that is being recorded.

Note: If required, recording the guideline can be paused.

4. At the end of the curved swath, select **Complete Identical Curve**





 to indicate the end of the curve recording.

An option to activate (select) the new guideline is shown, if another line has already been activated.

An option to rename the new guideline is displayed.

14.4. Using center pivot guidelines

Some fields are best worked in a circular shape. This setting allows the operator to create guidelines around a center pivot point.

1. Select **Guideline Menu**  / **Create Guideline**  / **Record Pivot** .
2. Position the vehicle at the start point of the curve and select **Start center pivot recording** .
3. Drive around the center of the field. A pivot accuracy bar is displayed to indicate the progress of guideline creation.

When the system reaches the necessary accuracy to create the pivot, the recording will stop automatically. Alternatively, you can

press the **Complete Pivot** button  to approximate the pivot that has been driven so far.

Once the system detects the arc, circular guidelines are created, based on the width of the implement.



Note: Remember to consider the turning circle of the vehicle and implement when driving the first arc.



An option to activate (select) the new guideline is shown, if another line has already been activated.

An option to rename the new guideline is displayed.

14.5. Using guidelock guidance mode

Guidelock is a coverage based guidance mode. It generates a curve based on existing coverage, regardless of when that coverage was laid. This is convenient if wanting to steer around a contour but you don't want to create and save a curve, or if you want to continue steering alongside some coverage that was treated earlier that you did not save a curve for. This guideline method is sometimes referred to as 'free form'.

1. Select the guidelock option  in the view controls at the top of the guidance screen to switch in and out of guidelock mode. The black (or white) icon indicates that guidelock mode is off and the colored icon  indicates that it is on. See [Using view controls, page 129](#).

Alternatively, select the Cycle guidance mode button  from the guideline menu. It will change to  when guidelock is enabled (available if boundary steering is enabled).

A guideline is generated that follows whichever path the vehicle takes.

14.6. Using boundary steering

This option generates a guideline inside the boundary. By default, the guideline is offset by half an implement width away from the boundary. This width can be adjusted using the nudge menu (see [Nudge Menu, page 229](#)).



Note: Ensure the guideline is a sufficient distance away from the boundary to avoid colliding with fences etc.

As the vehicle moves towards the center of the field, more guidelines are created. Guidelines are spaced one implement width apart.



To use this option, a boundary must exist. See [Setting a new boundary, page 168](#).

1. Ensure **Boundary Steering** is enabled via the setup menu **System**



2. Press and hold to select the boundary on the touchscreen. The boundary is highlighted.

3. Select the  icon from the popup menu.

Alternatively, select the Cycle guidance mode button  from the guideline menu. It will change to  when boundary steering is enabled.

This option can also be used to steer around the boundary of exclusion zones if **Exclusion Headland** is set to **Yes** (see [Editing a boundary, page 172](#)).

14.7. Using project lines

Note: This option is only available if Controlled Traffic is enabled. See [Guidance setup, page 50](#). A license is required. Enabling this option also enables guideline groups (see [Guideline Groups, page 214](#)).

Project Lines does not generate waylines. Only the path that each Project Line follows can be used for guidance or auto steering.



Due to GPS drift, it may be necessary to adjust the position of the lines used in Controlled Traffic mode. See [Compensating for GPS drift, page 231](#).

Project Lines can be created by generating As-Driven Lines from the coverage recorded in a selected task, or by modifying an existing set of Project Lines. There are two methods available for modifying existing Project Lines; Splitting Lines and Adding Offset Lines.

14.7.1. Generating as-driven lines

When generating Project Lines from coverage, a Project Line is created between the points where coverage was started and stopped, and follows the same path that was taken when recording the coverage.

Follow these steps to generate as-driven lines:

1. Select **Guideline Menu**  / **Create Guideline**  / **New Project Lines** , then select next.
2. Select **Method**, select **Generate As-Driven Lines** and confirm, then select next.
3. Select the task that has the coverage that will be used to generate as-driven lines and select next.
4. Select **Project Lines Name** to enter a new name for the new set of Project Lines, then select next.
5. Once the new lines have been generated, confirm again to finish.

After the new Project Lines have been generated, they are automatically loaded and ready for use.

14.7.2. Splitting existing project lines

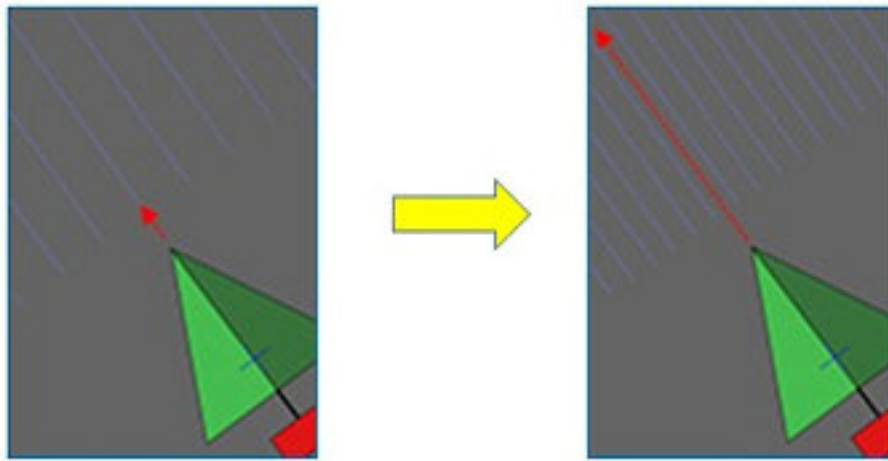

The Split Lines option is used to create a new set of Project Lines where each line in the selected (original) set of Project Lines is split in to two lines.

The new lines are placed either side of the original line, and are separated by a distance entered by the operator. The original lines are not added to the new set of Project Lines.



Note: For sugar cane applications, this option can be used to create lines that can be used for a single row harvester from the project lines that were used for guidance for a two-row planter.

Follow these steps to create a new set of Project Lines by splitting an existing set of project lines:

1. Select **Guideline Menu**  / **Create Guideline**  / **New Project Lines** , then select next.
2. Select **Method**, select **Modify Existing Project Lines** and confirm, then select next.
3. Select **Modification Type**, select **Split Lines** and confirm, then select next.

14.7. Using project lines

4. Select the existing set of Project Lines that will be used to generate the new set of Split Lines and select next.
5. Select **File Name** to enter a name for the new set of Project Lines and confirm, then select next.
6. Select **Offset** and enter the offset (the distance between each original line and the corresponding new Split Lines) and confirm, then select next.

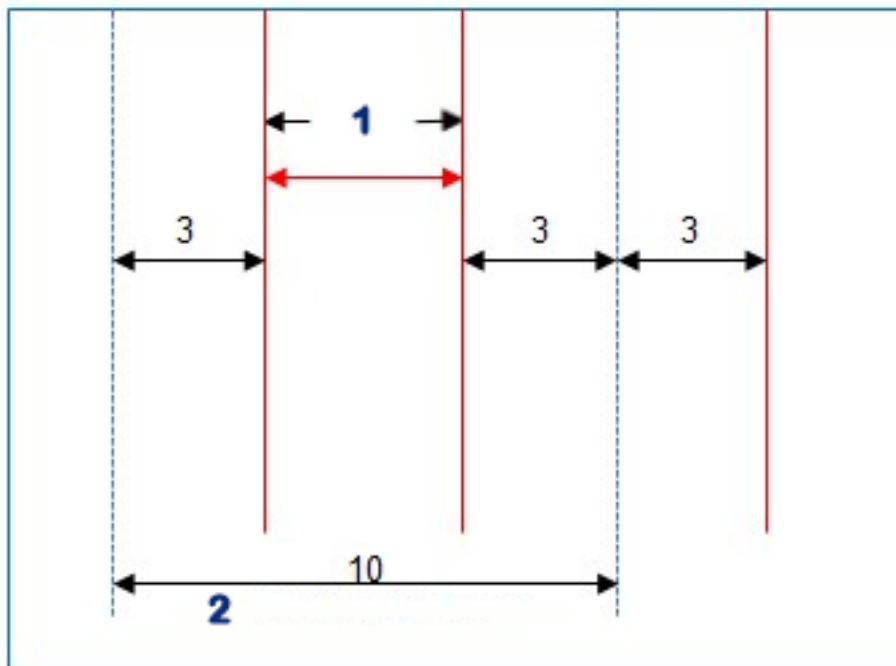

1 Split lines

2 Original lines

After the new Project Lines have been generated, they are automatically loaded and ready for use.

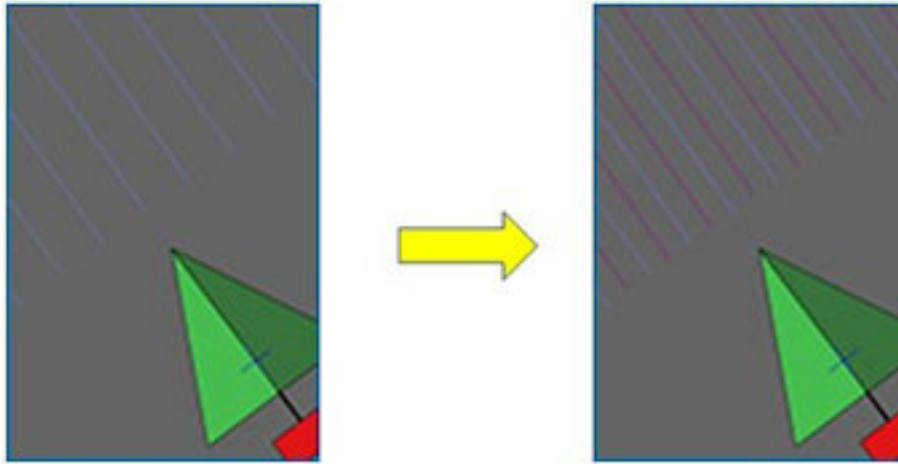

14.7.3. Add offset lines for existing project lines

In the case of the Add Offset Lines options, each of the lines in the original set of Project Lines are copied in to the new set, offset lines are added to these so that one offset line is placed centrally between each of the existing lines.



Note: For sugar cane applications, this option can be used to create lines that can be used for guidance for transport during harvest from the project lines that were used for guidance for a 2-row planter.

To create a new set of Project Lines by adding offset lines to an existing set of project lines:

1. Select **Guideline Menu**  / **Create Guideline**  / **New Project Lines** , then select next.
2. Select **Method**, select **Modify Existing Project Lines** and confirm, then select next.
3. Select **Modification Type**, select **Add Offset Lines** and confirm, then select next.
4. Select the existing set of Project Lines that will be used to generate the new set of Offset Lines and select next.
5. Select **File Name** to enter a name for the new set of Offset Project Lines and confirm, then select next.
6. Select **Row Spacing** and enter the original row spacing used. Confirm and select next to begin generating the new lines.

14.7. Using project lines

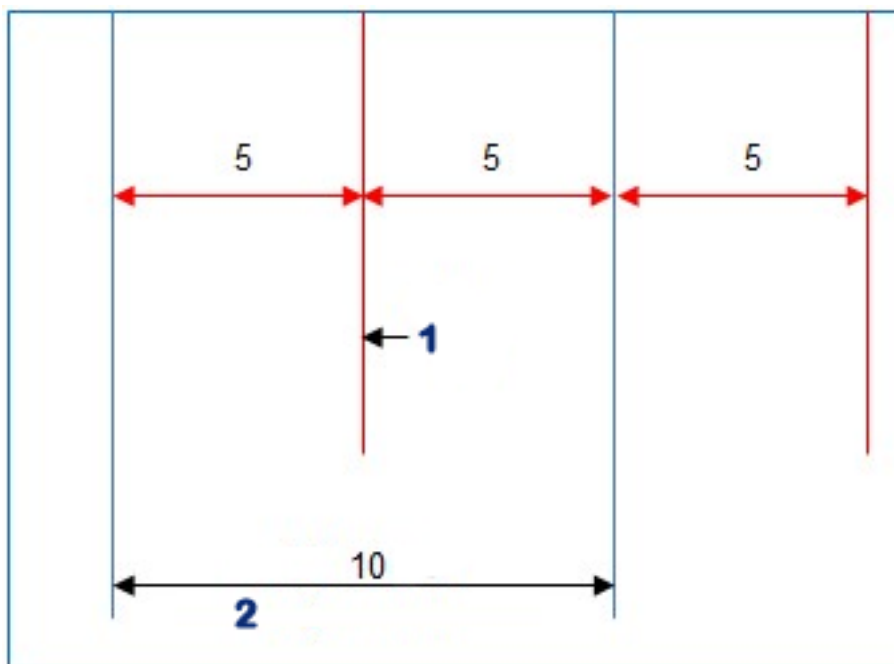

1 Offset line

2 Original lines

After the new Project Lines have been generated, they are automatically loaded and ready for use.

Note: This operation can take several minutes to complete for larger fields (1000 lines or more).





14.8. Setting up tramlines

Horizon software can display a visualization of tramlines when using AB lines or identical curve guidelines. Tramlines display an indication of where the wheels of other farm equipment will travel that should not be seeded.

Note: Tramlines are only a visual indicator, they do not control the implement operation.

A boundary must be setup prior to setting up tramlines, see [Setting a new boundary, page 168](#).

There must also be an active guideline, see [Guideline Menu, page 187](#). This is displayed in red.

1. Ensure **Tramlines** are enabled via the setup menu **System**  / **Features**  / **Guidance**  .
2. Select **Guidelines Menu**  / **Configure Tramlines**  .

Configure Tramlines	
SPACING	30.0 m
TRACK WIDTH	0.0 m
FIRST SWATH	0
OFFSET	0.00 m
	<input type="button" value="Cancel"/> <input type="button" value="OK"/>

- **Spacing:** The distance between the centers of the tramline passes. Usually this will be the width of the sprayer.

14.8. Setting up tramlines

- **Track width:** The distance between the outsides of the wheels of the vehicle that will steer to the tramlines.
- **First swath:** The swath that the seeding run will start on. From here, the edge of the field is calculated and shown as a light blue line. By default this line is shown half an implement width away from the first swath. This can be changed by adding an additional offset (below).
- **Offset:** This is any additional offset to be applied. For example, if you won't be seeding a full pass on the first run.
- **Auto configuration**  : Selects the first swath based on the current position and sets the offset to 0. It sets the edge of the field at half the current implement width from the current active guideline. For a 6 m implement, this would be 3 m from the active guideline. The system automatically detects on which side of the implement the field boundary is and sets the light blue edge line accordingly. **First Swath** and **Offset** can be adjusted manually.

For example, if the tramline spacing is a multiple of the current implement (6 m seeder and 18 m tramlines) and the first wayline is at the edge of the field, the configuration should be **First Swath** at 0 and **Offset** at 0.

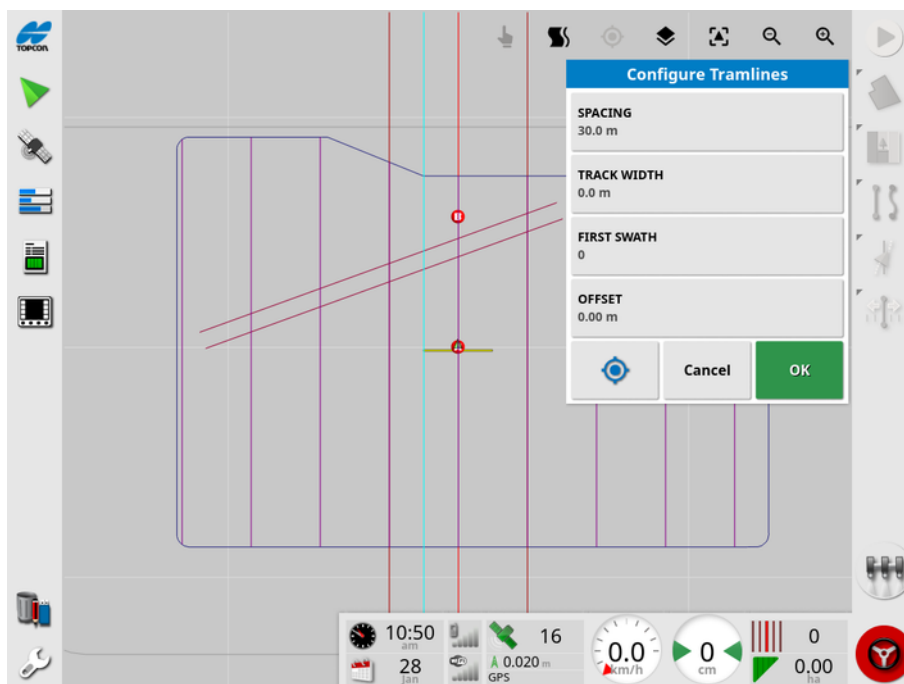

The tramlines are shown in purple and an alarm is shown to advise a user they are on a tramline pass. The tramline pass alarm displays if the vehicle is driving across a tramline.

Tramlines may be displayed / hidden via an option in the map layers



. See [Select visible map layers, page 132](#).

Configuring tramlines creates a new tramline guidance line with '_ Tramline' added to the current guidance pattern name. These tramlines can be exported via the Inventory Manager (found under Guidelines category) for use on other vehicles. See [Inventory Manager, page 248](#).

Note: Imported tramlines cannot be reconfigured.

Note: If guideline groups are enabled, configuring tramlines creates a new tramline guideline group, rather than an individual line.

14.9. Configure headland turns

This option provides the ability to autosteer around headland turns when using AB lines or identical curve guidelines. A selection of patterns are available to provide coverage.

Auto steering must be engaged to perform headland turns automatically. See [Auto Steering, page 219](#).

Note: To use this option, **a boundary must exist** (see [Setting a new boundary, page 168](#)) and **a headland must be configured** (see [Setting up a working headland, page 174](#)).

1. Ensure **Headland Turns** are enabled via the setup menu **System**



2. Select **Guidelines Menu**  / **Configure Headland Turns** .

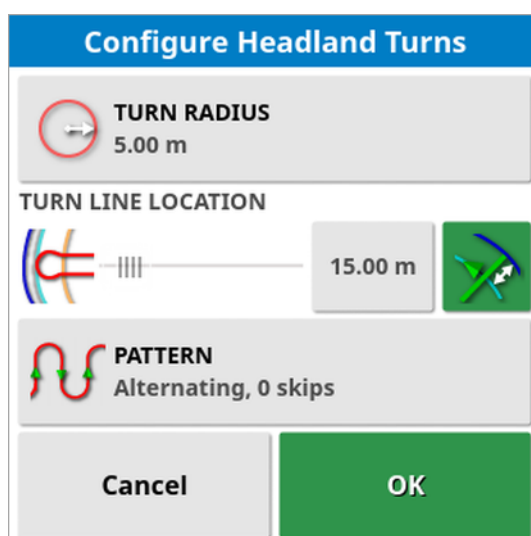

Note: The settings entered on this screen are saved per implement.

Tip: When the configure headland turns screen is displayed, a light blue line is displayed inside the boundary to show where the headland turns will be performed. Drive the vehicle to a location close to the headland to allow you to see the shape and position of the turn as you adjust the settings.

14.9.1. Turn radius

- **Turn radius:** The radius of the turn that is possible for the combined vehicle and implement to safely perform.



WARNING: The turn radius must be set high enough to allow the vehicle and implement to turn without jack knifing.

Tip: Start with the turn radius set to half of the implement's width, which will give you a smooth curve from one line to the next (unless doing skip rows.) Once you are comfortable with the way the turn is performed, you can try adjusting the turn radius to optimize the turn to suit your requirements. A smaller turn radius will result in the vehicle turning at the end to follow the boundary for a short distance before turning back onto the next line. A turn radius larger than half the implement width will result in a keyhole shaped turn.

A small turn radius provides a rectangle shaped turn with rounded corners.

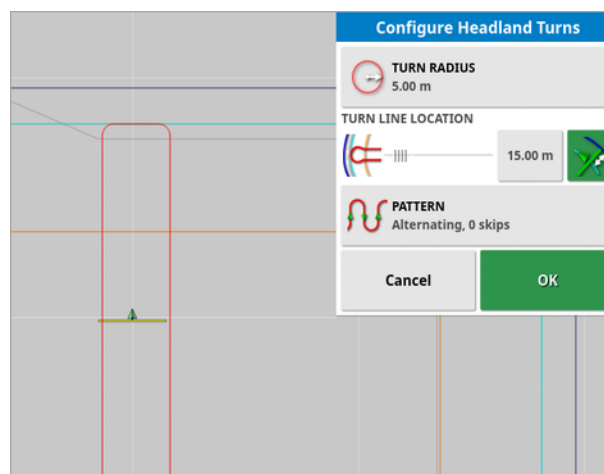

14.9. Configure headland turns

A turn radius of half the implement width provides a smooth, round turn.

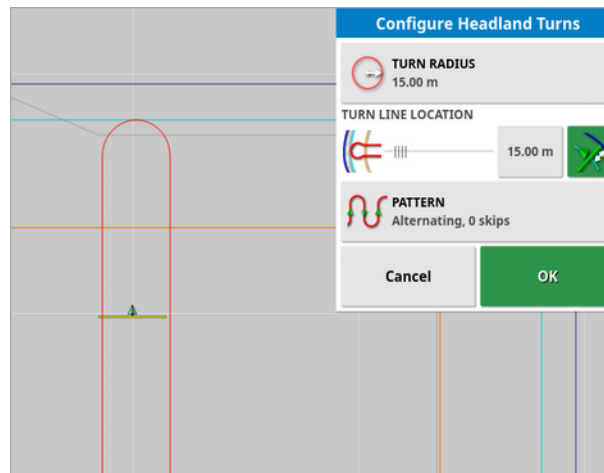

A larger turn radius provides a keyhole shaped curve.

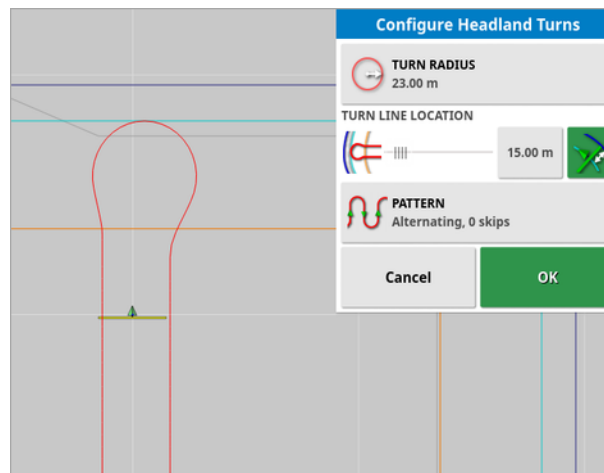

Note: To ensure that the implement is correctly on the line when exiting the headland (returning into the field) the shape of the curve may be such that the vehicle's initial movement is away from the next line, or the approach to the next line may have the vehicle overshoot the line. This is intentional and helps to ensure that the implement enters correctly without leaving gaps. See the following image.

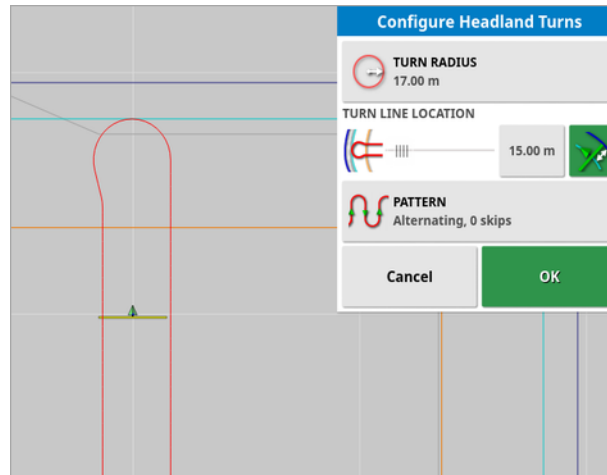

14.9.2. Turn line location

- **Turn line location:** Moves the location at which the turns will be performed between the headland and the boundary. (The location is indicated by the light blue line.) The left of the slider is the boundary and the right side is the **Headland Width** (see [Setting up a working headland, page 174](#)).

- : Distance from the boundary at which the turn will be performed to prevent the implement from hitting the fence during turns. The margin is measured from the center of the vehicle to the boundary. This field displays the **Turn line location** slider position, or can be used to enter a specific distance.

Note: If the implement geometry has an inline offset entered, this may move the position from which the margin is measured. See [Setting the implement geometry, page 115](#).

- : Increase the boundary margin by half the implement width. This figure is added to the figure displayed in the previous field.

Tip: Start with the turn location set to the implement width to ensure sufficient clearance from the boundary. Once you are comfortable with how the turn is performed, you can reduce the turn location to be closer to the boundary to suit your requirements.

14.9.3. Pattern

- **Pattern:** Opens the Pattern screen:

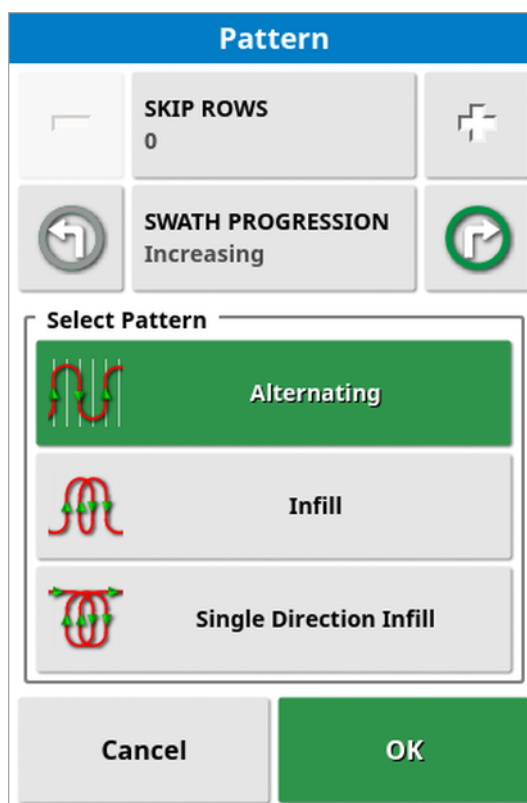

This screen is used to define the pattern that will be used by the vehicle to travel through the field.

- **Skip rows:** Skip one or more rows at each turn.
- **Swath progression:** Travel progresses through increasing or decreasing swath numbers displayed on the guidelines. To view all

guideline numbers across the field (if using AB lines), select from the top of the screen and choose **Line Numbers**.



14.9.4. Select pattern

Alternating

Vehicle travels up one row and down the next. Skip rows can be used if the implement is too large to make the turn onto the adjacent row.

Zero rows skipped

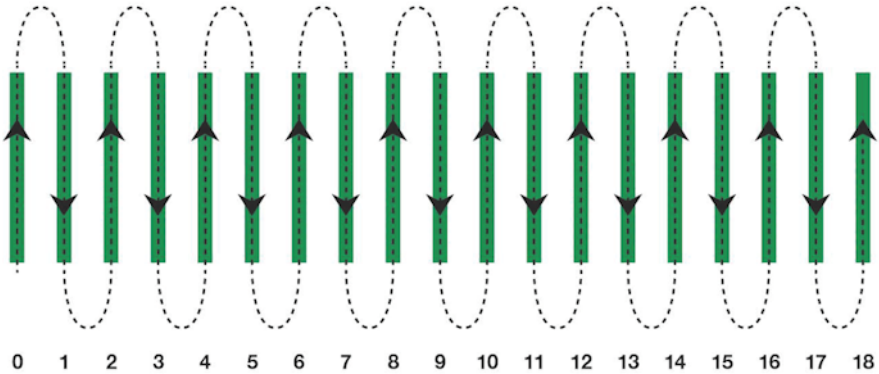

One row skipped

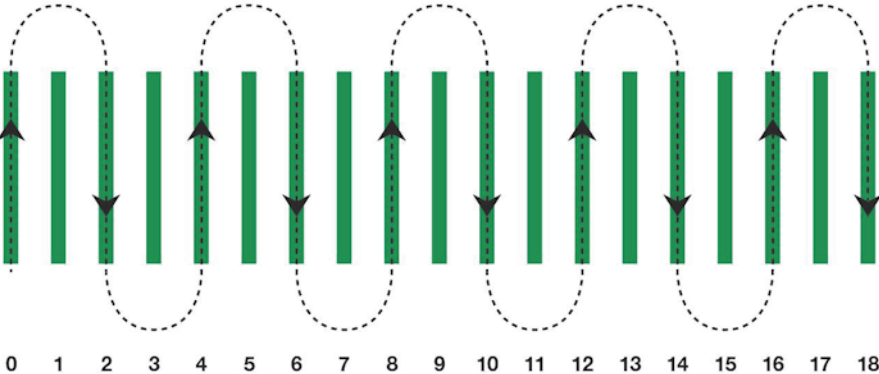

Infill

Vehicle skips a row and then turns back to fill in the skipped row. More than the defined number of rows may be skipped to complete the pattern.

One row skipped

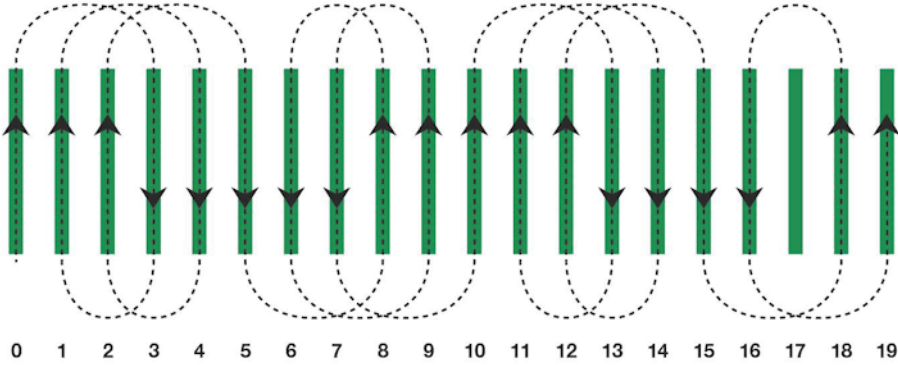

Two rows skipped

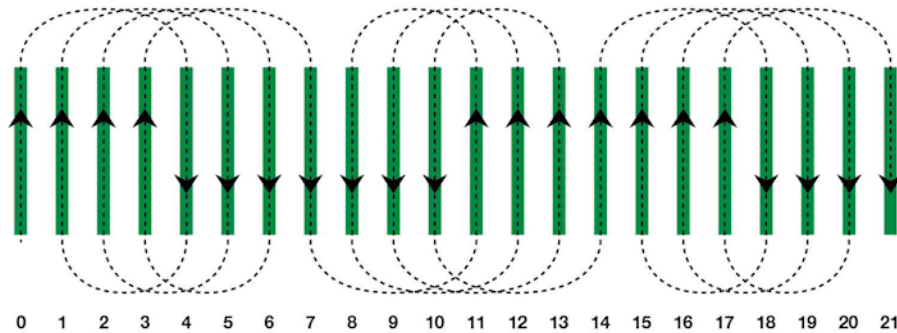

Single direction infill

Vehicle only turns in the same direction (left or right) at the end of each row. More than the defined number of rows may be skipped to complete the pattern.

One row skipped

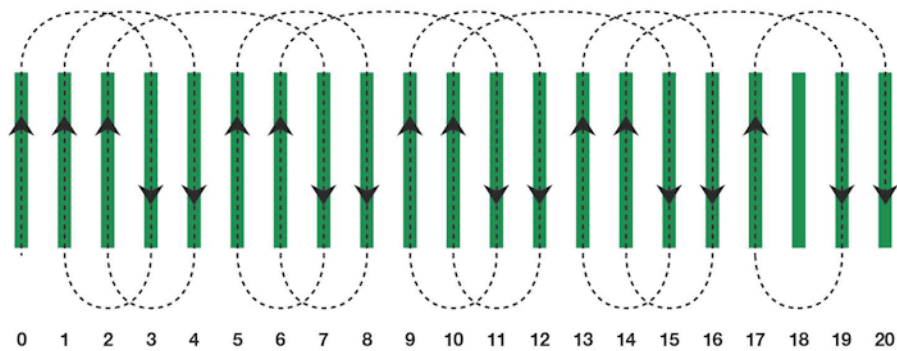

Three rows skipped

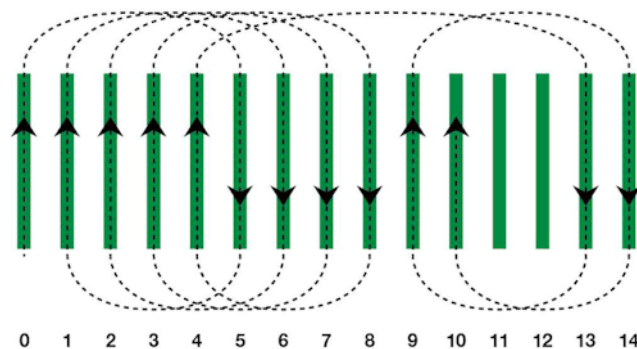

14.9.5. Headland turn alarm

As the vehicle approaches the headland, an alarm is displayed. This alarm allows the turn to be edited or cancelled.

Configure headland turn alarm

1. On the setup menu, select **System**  / **Alarms**  / **General**  / **Headland Turns** to configure the headland turn alarm.

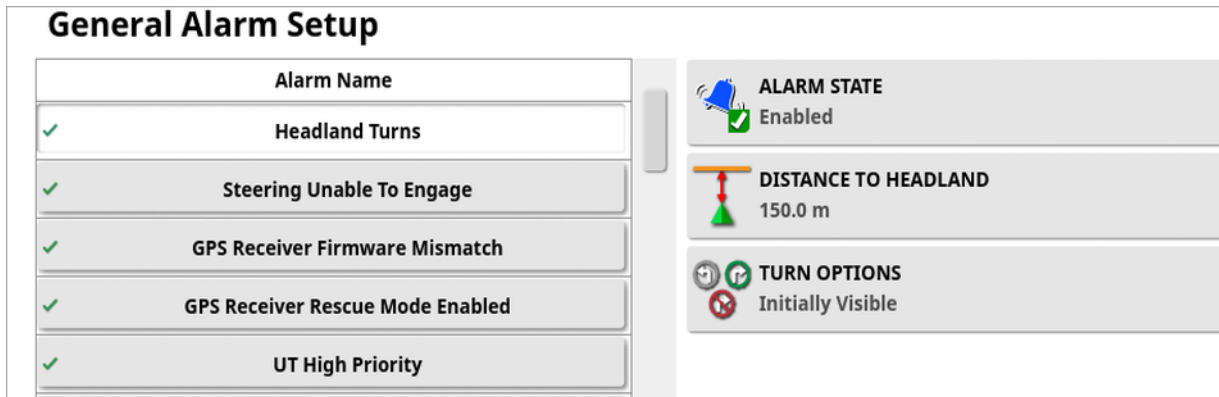

- **Distance to Headland:** The distance from the headland at which the alarm displays.
- **Turn Options:** Sets whether the edit headland turns options are displayed on the headland alarm by default.

Edit headland turns via alarm

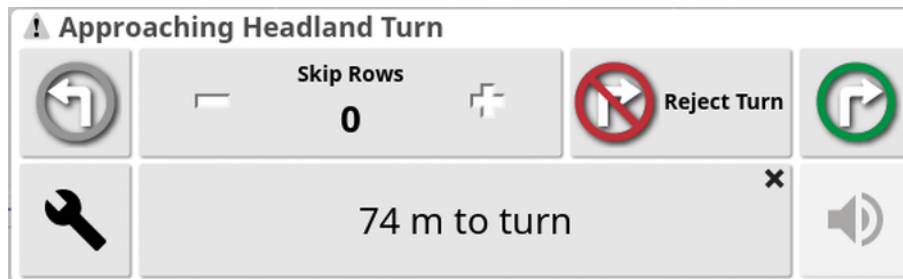

The alarm screen may be used to change the direction of the turn, change the number of rows to be skipped, or reject the turn. Pressing the alarm accepts the headland turn.

Note: This alarm can be displayed manually using the  button at the top of the guidance screen if required. The displayed button changes



between no turn , left turn  and right turn  to show the next action.

Chapter 15 – Guideline Groups

The Guideline groups option creates guidelines in groups to make managing the guidelines easier. Each field has a default group and the operator can immediately begin creating guidelines inside this group.

Using guideline groups may be useful if, for example:

- You only want to use some of the guidelines in a field for a particular tasks, or
- If you have a different set of guidelines for each of the implements that work in this field you may want to store the set of guidelines for each implement in a named group, or
- If you have a different set of guidelines you want to use this year as compared to last year because you are doing inter-row seeding. You may want to store this year's guidelines in a named group to avoid confusing them with last year's lines.

1. To enable guideline groups, select **System**  / **Features**  / **Guidance**  . Select **Guideline Groups** and select **Enabled**.

Note: Guideline groups were enabled by default in previous versions of Horizon 5, so must now be enabled if you wish to continue using groups.

The default guideline group is given the same name as the field. This may be changed via the Inventory Manager, **Guideline Groups** category. See [Inventory Manager, page 248](#). If required, groups can be named to relate to a series of guidelines (for example a group of guidelines to be used by the seeder and another group of lines to be used by sprayers).

A group can contain guidelines of more than one type. All the guidelines within a group are visible on the map at the same time. A group can contain a maximum of 20 guidelines.

To create a new guideline group for the current field, select **Guideline Group Menu**





/ **Create New Guideline Group**  to display the **New Guideline Group** window. The default name may be changed.

To change between guidelines, see [Selecting an existing guideline, page 189](#).

A guideline group can be deleted via the Inventory Manager.

15.1. Selecting an existing guideline group

Once guidelines have been created within fields, these are stored and can be accessed on future tasks in the field.

1. From the **Guideline Group Menu** , select **Select Guideline Group** . Existing guideline groups for the current field are listed.
2. Select the guideline group required and confirm.

15.2. Importing existing guidelines

Guidelines can be imported via TAP or via USB from other displays or from shapefiles, or copied into the current group.

Note: To import a guideline group from another display or to import an individual guideline, you must use the inventory manager (see [page 248](#)).

15.2.1. Import guidelines from USB

This function can be used to import one or more guideline or shapefiles into the currently active group.

Note: Guidelines exported from a Horizon display prior to version 5 should be stored in the full Client/Farm/Field structure to be properly imported.

1. Ensure the USB containing the required guidelines is inserted into the display.

2. From the **Guideline Group Menu** , select **Import Existing**

Guideline . The insert existing guideline wizard displays.



3. Select next and select **Import Guideline** from the drop down menu, then select next.

4. Select the USB icon  at the base of the screen.

5. Navigate to the location on the USB containing the guidelines or shapefile.

6. Highlight the required files and select next. The guidelines are imported into the current group and associated with the current field.



15.2.2. Import guidelines from TAP

1. Ensure the display is connected to TAP.
2. From the **Guideline Group Menu** , select **Import Existing Guideline** . The insert existing guideline wizard displays.
3. Select next and select **Import Guideline** from the drop down menu, then select next.
4. Select the TAP icon  at the base of the screen.
5. Navigate to and highlight the required files and select next. The guidelines are imported into the current group and associated with the current field.

15.2.3. Copy guidelines

When upgrading from Horizon 4.04 or earlier to Horizon 5.0, each guideline is imported as a separate group containing one line. If required, the lines can be combined into a single group by selecting one line and copying the other lines into that group.

The copy guidelines function is useful when combining a group that may contain a single line into a group with multiple lines.

1. From the **Guideline Group Menu** , select **Import Existing Guideline** . The insert existing guideline wizard displays.
2. Select next and select **Copy Existing Guideline** from the drop down menu, then select next.
3. Select the field containing the required guideline group and select the required group, then select next.

The guidelines are inserted into the current group and associated with the current field.

Chapter 16 – Auto Steering

The Steering Options Menu allows the operator to set options for the auto steering. To use this feature, it must be enabled. If it has not been enabled, see [Guidance setup, page 50](#) to enable auto steering.

To calibrate the steering see [Steering Calibrations, page 147](#).

16.1. Auto steer status

Auto Steer Status allows the operator to view the status of the conditions required for auto steering. Red indicates that the conditions are not met and therefore steering is not ready.

1. To review the status of the auto steering, select **Steering Options**

Menu  / Auto Steer Status .

The Steering Status screen displays.



Green indicates that the item is ready.

Red indicates that the item is not ready.

Steering alarms may be displayed by selecting the steering alarm button at the bottom left of the screen.

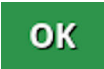
2. Select  to return to the main screen and complete the necessary actions (work through issues displayed from the top to

the bottom of the screen).

16.1.1. Auto steer troubleshooting

Error Display	Actions	Page
 <p>The screenshot shows a 'Steering Status' panel. At the top left is a red warning icon. Below it, the panel title 'Steering Status' is in a blue header. A list of items follows, each with a status icon: Receiver hardware (green check), Differential correction (green check), Position accuracy (green check), Steering controller (PVED) (green check), Vehicle geometry (red X), Vehicle profile (red X), Steering calibrated (green check), Lockout (green check), Wayline available (green check), Wayline synchronized (red X), Prohibited operation (green check), Operator presence (green check), Steering wheel (green check), Speed (green check), Crosstrack error (green check), and Heading error (green check). At the bottom left is a circular icon with '0' and at the bottom right is a green 'OK' button.</p>	<p>Auto Steering Engage is showing red. Auto steering does not engage. Select Auto Steering Engage to bring up the Steering Status panel. Red on the panel indicates that the item is not working correctly.</p>	
<p>Receiver hardware displays with red</p>	<p>Is the receiver connected correctly, mounted securely and turned on?</p>	
<p>Differential correction displays with red</p>	<p>Confirm setup in display matches the correction source requirements.</p>	<p>59</p>

Error Display	Actions	Page
Position accuracy displays with red	<p>Allow time for convergence to occur.</p> <p>What color is the satellite icon on the dashboard? How many satellites show next to the icon? You need at least four satellites available.</p> <p>Is the correction source correct? If not, select the appropriate correction source.</p> <p>Are you in an open space away from power lines? Drive to an open space and allow time for convergence.</p> <p>If on a subscription scheme, confirm current subscription. Confirm correct frequency has been set.</p>	59
Steering controller displays with red	<p>Confirm controller is connected and turned on.</p> <p>Confirm that the correct steering controller has been selected during setup.</p> <p>If using AES, power cycle the AES, then turn wheel a ¼ turn to enable steering.</p>	101
Vehicle geometry displays with red	<p>Return to Setting the Vehicle Geometry and reset dimensions correctly or re-select the vehicle profile.</p>	99
Vehicle profile displays with red	<p>Review which vehicle has been selected and review geometry.</p>	96-99

16.1. Auto steer status

Error Display	Actions	Page
Steering calibrated displays with red	Confirm calibrations have been done for this vehicle. Drive to an open space away from power lines and obstacles, reboot and repeat calibrations.	148-151
Lockout	<p>The steering system has been put into a transport mode (i.e. when driving on a highway) so that the steering cannot be inadvertently engaged.</p> <p>This error may also be triggered if there is a fault with the wheel angle sensor or the steering controller has reported an error using that message.</p>	
Wayline available displays with red	Drive closer to the wayline (guideline). Confirm that guideline has been created and selected.	190-194
Wayline synchronized	Wayline (guideline) is not successfully loaded. Confirm connection with receiver and reload the wayline. Note that it may take some time for the wayline to be uploaded to the receiver, particularly for large curves.	
Prohibited operation	Steering cannot be engaged while certain actions are being performed. For example; steering calibration, changing GPS settings, exporting a task.	
Operator presence	The steering system will disengage if the driver leaves the control seat.	

Error Display	Actions	Page
Steering wheel	Let go of the steering wheel and try again.	
Speed displays with red	Adjust speed to between 1 and 25 kph (0.7-15 mph). The necessary speed may vary with the vehicle.	
Cross track error displays with red	Drive closer to the guideline before engaging auto steering.	
Heading error displays with red	Check the angle or reduce the speed of the vehicle's approach to the guideline.	

16.2. Tuning auto steer

It is important to tune the auto steering to suit the conditions, the type of task and the type of vehicle/implement.

1. Select **Steering Options Menu**  / **Auto Steer Tuning Parameters**

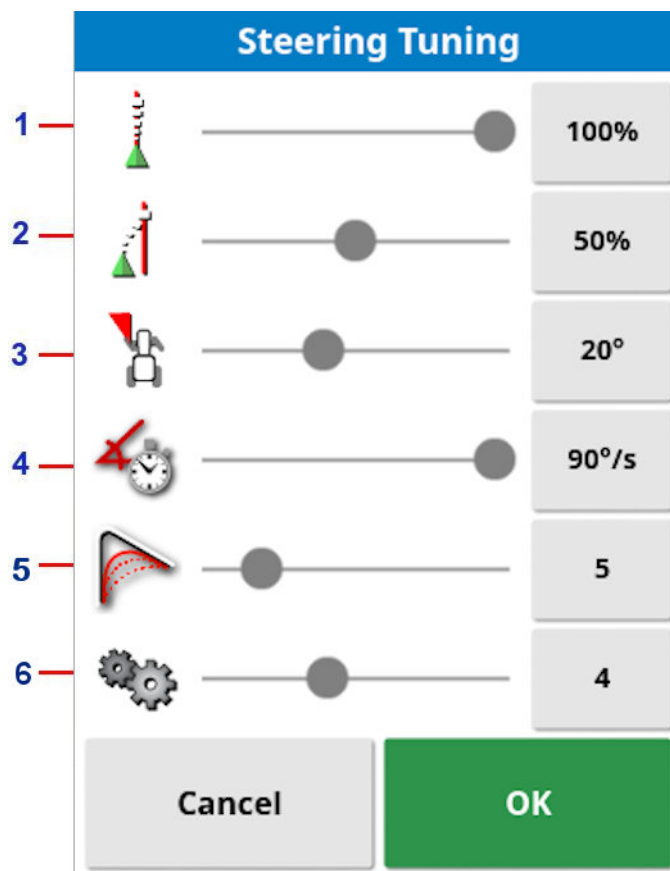

- 1 Online Aggressiveness sets how aggressively the steering will try to follow the guideline. Set to suit the precision necessary for the task.
- 2 Approach Aggressiveness sets how aggressively the steering will approach the line. If too high, the vehicle may turn sharply. Set considering the accuracy for the task and safety for equipment users.

- 3 Maximum Steering Angle limits the angle of turn to stay within the limits of the vehicle's safe capability. Set to safe levels for the vehicle and any implement being towed.
- 4 Maximum Steering Rate limits how many degrees per second the wheels can turn. Lower values will decrease issues such as self propelled boom sprayers having the booms whip around too quickly or excessive cabin movement in articulated tractors.
- 5 Smoothing Radius for Curve Waylines sets how tight or loose the auto steering will adhere to curved waylines. Set to an appropriate level. Lower values will follow the curved waylines more closely.
- 6 Wayline Selection Aggressiveness uses the Maximum Steering Angle and the swath spacing to determine which wayline is selected next. If set at 10, the wayline closest to the vehicle is selected and if set at zero, the next selected wayline may be a few swaths away to ensure a gentle approach. The default value is 4.

AES

Note that if **AES** is selected in the setup screen (**Vehicle / Steering / CONTROLLER**), three new options are added to this screen:

- **AES Sensitivity Adjustment:** Adjusts the responsiveness of the steering when following guidelines.
- **AES Deadband Adjustment:** Adjusts the amount of movement the AES needs to make before the wheels respond.
- **AES Disengage Threshold:** Adjusts the amount of effort required to disengage the steering wheel.

16.3. Engaging auto steer

To use auto steering, the operator must have:

- Established guidelines ([page 187](#))
- Enabled auto steering on the display ([page 50](#))
- Calibrated the steering ([page 147](#))
- Confirmed that all Steering Status items are green ([page 219](#))
- Set the auto steering tuning to suit the task and vehicle type ([page 224](#))
- Positioned the vehicle at the desired starting point.

1. Zoom and pan on the screen until the vehicle is in the center of the screen and at a comfortable size for viewing (if panning is enabled, see [Setting up map options, page 35](#)).

Note: If an external auto steering engage switch is to be used, this needs to be enabled during setup for the vehicle. See [Setting up the steering controller, page 101](#). If using an AES, turn on the AES and turn the steering wheel a quarter turn to enable auto steering.

2. Confirm that the Auto Steer Engage is showing white. This means it is ready to use.



Auto Steer is ready to use. Select **Auto Steer Engage** to begin.



Auto Steer is engaged and active. Select **Auto Steer Engage** to change back to manual control. Note that the button may briefly flash blue before turning green.



Auto steer cannot engage. Select **Auto Steer Engage** or return to the Steering Options Menu to see Steering Status for possible causes.



Auto steer is flashing in 'Delayed Engage' mode.

If Auto Steer is displaying red and the only condition displaying red on the Steering Status is easily resolved (for example speed), the operator may select **Auto Steer Engage** twice (double click) and flashing yellow will indicate that auto steer will engage if conditions are met within 15 seconds. If conditions are not met, it will return to red.

3. Correct any issue displaying red in the Steering Status Panel (work through issues displayed from the top to the bottom of the screen). When **Auto Steer Engage** is white, auto steer is ready to engage. For more information on Steering Status Errors see [Auto steer troubleshooting, page 220](#).
4. Drive slowly to meet a guideline, heading in the desired direction.
5. Select **Auto Steer Engage**. It will turn green. The vehicle will steer to the nearest guideline.
6. If it steers towards the line too aggressively, stop, disengage auto steering and adjust the Auto Steer Tuning Parameters from the Steering Options Menu.

16.4. Disengaging auto steer

Auto steer will automatically disengage when the necessary conditions (shown on the **Steering Status** screen) are no longer met.

To manually disengage auto steering:

- Turn the steering wheel a few degrees OR
- Select the **Auto Steer Engage** button on the display to disengage OR
- If using an external steering switch, disengage using the switch.



WARNING: Before leaving the vehicle, disengage auto steer, turn off the steering switch and remove the key.



Note: A visual and audible alarm will display and sound whenever auto steer is engaged or disengaged. The volume can be adjusted. See [Setting up alarms, page 70](#).

Chapter 17 – Nudge Menu



The Nudge menu allows for minor adjustments to the guidelines that have been set. This is useful for slightly realigning the guidelines to changing conditions or when returning to a field the next season. Guidelines can be nudged in a number of ways.

Nudge works with AB lines, center pivot guidelines and identical curves.

17.1. Using nudge options

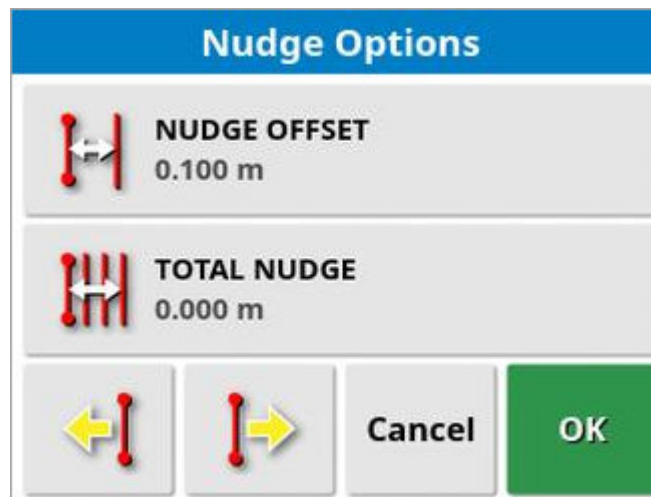
1. Select **Nudge Menu**  / **Open Nudge Options** .
2. To set how far a nudge will move a line, select **NUDGE OFFSET**.



3. Enter the required **NUDGE OFFSET**.
4. Use **Nudge Left**  or **Nudge Right**  on the Nudge Options screen or on the Nudge menu to nudge the lines.
5. **TOTAL NUDGE** calculates the total distance nudged. Select this to set a total nudge offset or to reset to 0.
6. Select **Save Nudged Guideline**  to save the new guideline positions.

17.1. Using nudge options

If guideline groups are enabled, all lines in the group that have been nudged are saved in their new position. Lines that have not been nudged remain in their original position.

Nudging to the vehicle's position

To align the guidelines to the vehicle's current position:

1. Select **Nudge Guideline to the Vehicle's Position**



Note: When nudging a curve or pivot, the size of the curve (or radius of the pivot) will change.

17.2. Compensating for GPS drift





GPS Drift may occur over time (when using low accuracy correction sources). When the operator returns to a field, there may be a slight change in the reported vehicle position with respect to fixed objects such as the field boundary or guidelines. This is largely due to changes in the satellite constellation patterns.

Other factors such as having no clear access to the sky (operating near trees or other obstacles) and satellite data errors may also result in a drift.

Note: It is also possible to reposition the vehicle position to a selected flag point, see [Working with flag points, page 166](#).

To compensate for GPS drift:

1. Select **Nudge Menu**  / **GPS Drift Compensation** .

GPS Drift Options		
	GPS DRIFT INCREMENT 0.100 m	
	NORTH 0.000 m	
	EAST 0.000 m	
		
		
		
	Cancel	OK

The compensation value may be selected by:

Entering a positive or negative value in the **NORTH** and/or **EAST** field and confirming.

Or

Entering the required value in the **GPS DRIFT INCREMENT** field and then selecting the required direction button until the required compensation is achieved.

2. Select **Reset GPS drift**  to remove the selected GPS drift compensation.

17.2.1. Compensating correctly for GPS drift

When correcting GPS drift, the vehicle on the map will be moved relative to the other objects on the map (for example, the field boundary, guidelines, flag points and any previous coverage). The easiest way to

see this on the map is to switch to a North Up view  and pan the map so that the vehicle is visible next to the GPS Drift Options window.

To correctly compensate for GPS drift:

1. Drive the vehicle to an identifiable location within the field (for example, next to a gate, the corner of the field or in the previous year's wheel tracks).
2. Use the GPS Drift Options window to position the vehicle on the map relative to these fixed landmarks.

In order to do this more accurately and quickly, you may want to set a flag point at a marked location on the field. Then each time you return to the field, position the vehicle at that marked location, locate the flag point on the map and select it. This will open a window with the option

for 'GPS Drift Correction' . Selecting that option will move the vehicle to the location of the flag point.

The GPS drift compensation that is applied is remembered when the display is restarted. However, this compensation may no longer be accurate if conditions have changed. An alarm will be shown shortly after the system starts that will advise the operator that GPS drift compensation is in effect. The operator must then decide if they want to continue using this compensation factor, clear it back to zero or perform the GPS drift compensation procedure again to get a more accurate result for that session.

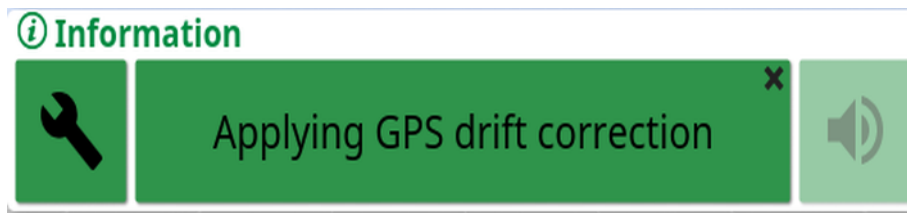

17.2.2. High accuracy correction sources

GPS drift compensation should not be necessary with higher accuracy correction sources (for example, RTK). If a high accuracy source is being used, the GPS drift compensation should be reset back to zero in the GPS Drift Options window.

Chapter 18 – Enabled Additional Features

This section describes the use of features that may have been enabled in the Setup screen: **System / Features**.

The enabled features documented in this section appear on the navigation bar.

18.1. Using auto section control

Auto section control is available when an implement and ECU have been set up and Auto Section Control has been enabled in **System / Features / Implement**.

1. Select **Auto Section Control** . The Auto Section Control mini-view opens.

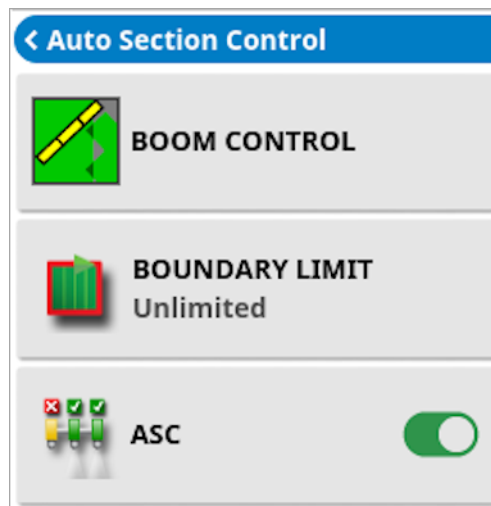

- **Boundary limit:** Sets which type of boundary limit will turn off coverage when using auto section control:
 - **Field Boundary** and **Headland** are defined using the Field menu. See [Setting a new boundary, page 168](#) and [Setting up a working headland, page 174](#) for more information.
- **ASC on/off:** Turn auto section control on/off on all booms.

18.1.1. Boom control

Single boom

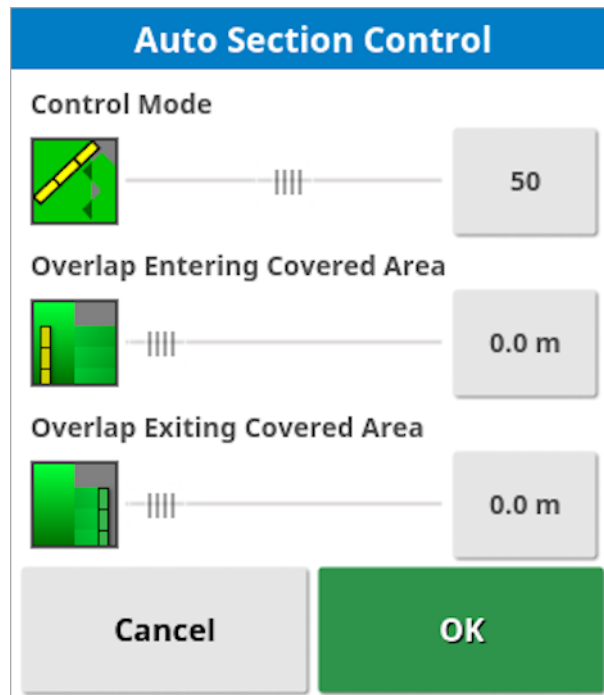

- **Control mode:** Use the slider or number keypad to set to avoid overlap (0) or avoid gaps (100). If avoid overlap is chosen, there may be some spaces where product is not applied. If avoid gaps is chosen, some overlap of application is likely near boundaries. The default (50) is a compromise.
- **Overlap entering / exiting covered area:** Determines how much overlap is achieved when entering or exiting an area that already has coverage.

Multiple booms

If the implement has multiple booms, the control mode and overlap covered area settings may be adjusted separately for each boom.

Select the required boom before adjusting the settings.

18.1. Using auto section control

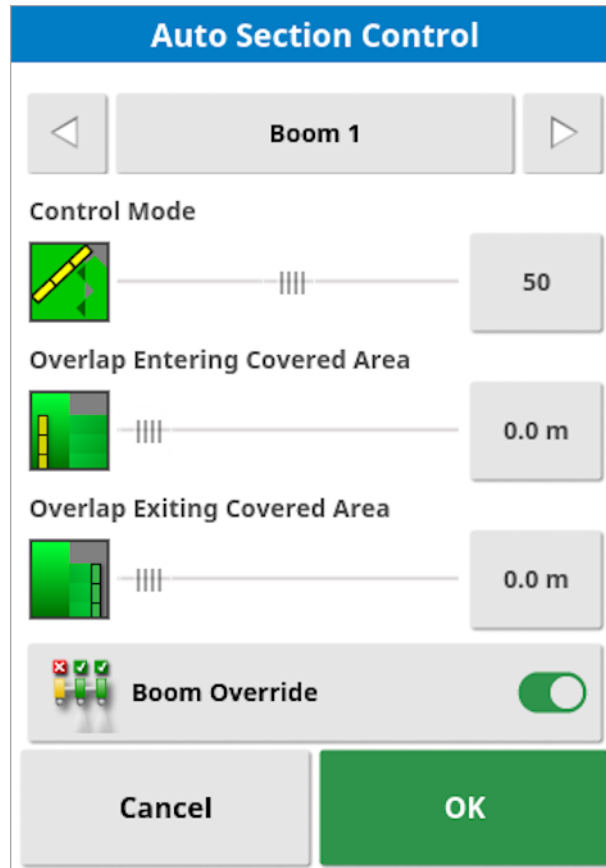

Boom override turns off section control for this boom. Select the required boom and press **Boom Override**. At least one boom must be turned on. Use **ASC on/off** on the mini-view to turn off all booms.

18.2. Using universal terminal (ISOBUS)

This option allows the operator to interact with an ISOBUS ECU.

The universal terminal is similar to the idea of a web browser. It has no context about what is running on it. User interfaces are loaded from the connected clients.

There is no practical limit to how many implements or clients can be accommodated by the universal terminal. Functionality is limited to the implement and controller design.

Universal terminal is enabled via **System / Features / Console**.

1. Select **Universal Terminal** from the Navigation bar to open the mini-view.

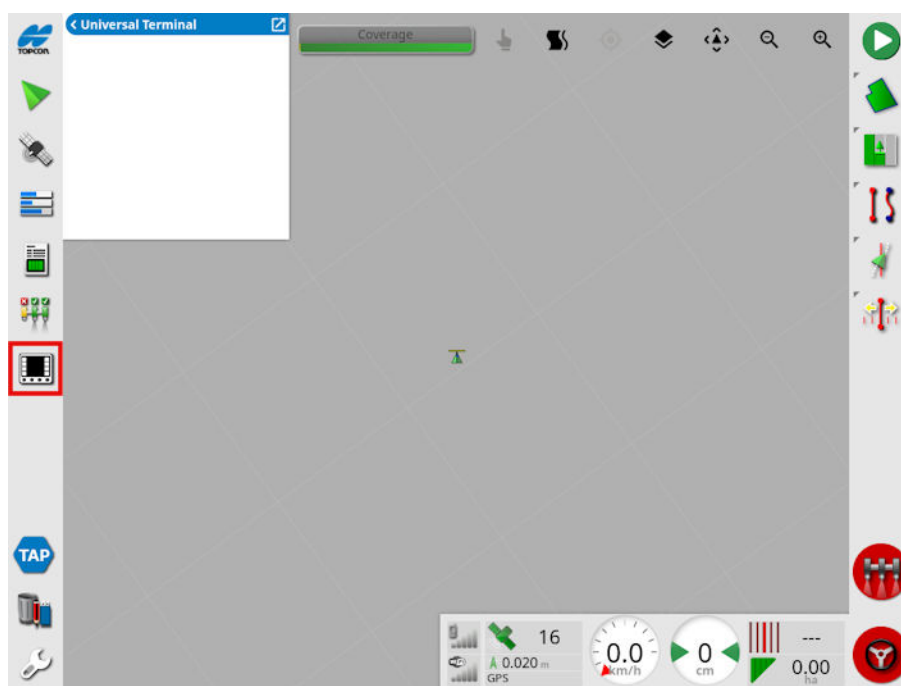

Note: The icon displayed for the universal terminal varies depending on the attached ISOBUS compatible equipment.

2. To open universal terminal in full screen, maximize the mini-view.

18.2. Using universal terminal (ISOBUS)

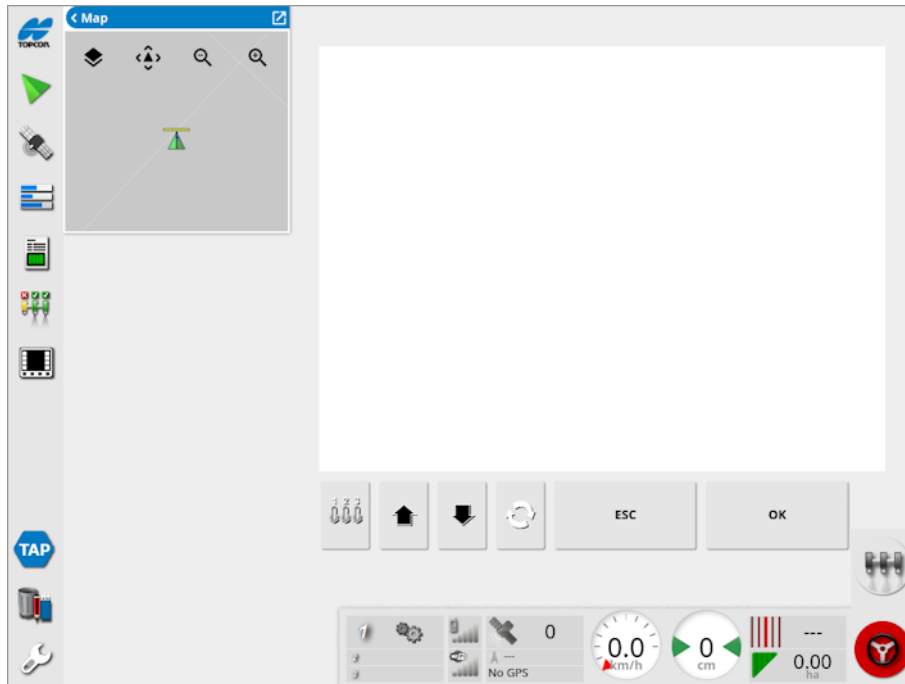

Screens will vary according to the ISOBUS equipment.



Opens the Aux-N Assignment window (see [Auxiliary control setup, page 85](#)).



Moves to the previous input or button.



Moves to the next input or button.



Cycles through the connected UT Working Sets.



Escapes out of an editing operation or acknowledges a UT alarm if present.



Activates the highlighted input or button.

18.3. Using weather station

The weather station port option is available under **System / Features / Console**. The CAN port to which the weather station is connected must be selected before use.

This option enables support for the AirMar 150WX Weather Station.

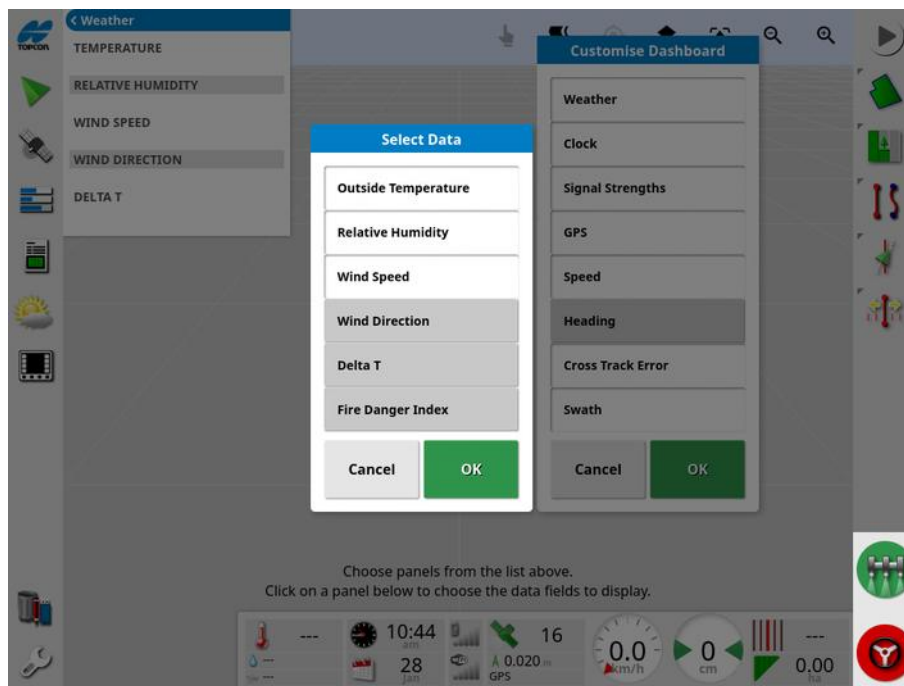

Once connected, both a mini-view and the dashboard can display temperature, relative humidity, wind speed, wind direction and Delta T.

Delta T is becoming one of the standard indicators for acceptable spray conditions. It is indicative of evaporation rate and droplet lifetime. Delta T is calculated by subtracting the wet bulb temperature from the dry bulb temperature.

Note: Weather station data will automatically populate task details. See [Viewing task information, page 140](#).

18.3.1. Calibrating weather station

Once installed, the weather station requires calibration.

Note: The vehicle must be in an open area, away from obstructions, where it is possible to turn the vehicle in circles.

18.3. Using weather station

1. Turn the weather station off and then on again.
2. Within two minutes of cycling the power, turn the vehicle in a slow circle (7 - 11 kph).





Once the vehicle has completed 1 1/2 turns, the auto calibration will begin.

3. Continue to perform two or three more circles without changing the vehicle's speed.

For more information, refer to the user guide supplied by the weather station manufacturer.

18.4. Using NORAC Boom Height Control

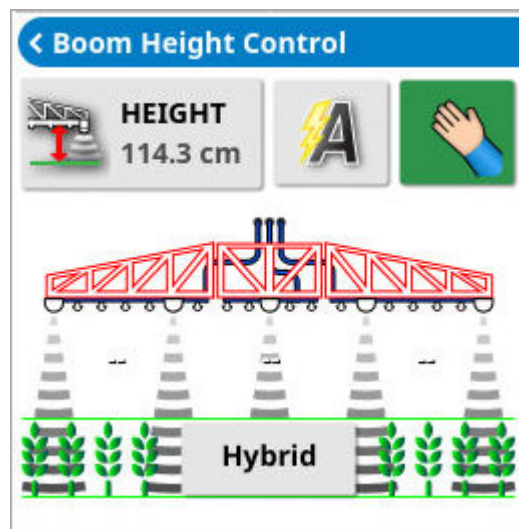

This option automatically controls the height of the boom above the ground or the crop canopy. It requires NORAC sensors and Electronic Control Unit (ECU) to be installed.

The NORAC boom height control option is available under **System**  / **Features**  / **Implement**  . Once enabled, a NORAC mini-view is available  .



Note: Setup of the boom height control system must be performed via the UT screen. Refer to manuals supplied with the NORAC system.

The following settings are available:

- **Target height:** The target height that the operator would like the boom to be set at when spraying in auto mode.
-  **Auto mode:** Boom height is automatically controlled.
-  **Manual mode:** Boom height is adjusted manually.
- **Mode:**
 - **Crop:** Reads the height from the spray nozzles to the top of the crop canopy.

18.4. Using NORAC Boom Height Control

- **Soil:** Reads the height from the spray nozzles to the ground.
- **Hybrid:** Uses a combination of the crop and soil readings. This is useful to avoid major boom movements for crops that are patchy.

18.5. Using plot planter

The plot planter option enables farmers to only plant in pre-defined parcels and to plant several varieties of seed within the same field.

The plot planter features only become available when a plot planter implement is active. To begin using the feature, first you must create an implement.

18.5.1. Creating a plot planter implement

1. Ensure plot planter is licensed.

2. Select **Implement**  / **New**  / **Custom** .

3. Use the arrows to select the implement **Type** and confirm.

A default name for the implement is shown.

Note: It is highly recommended that items are named in a thoughtful and structured way to allow easy use in future seasons.

4. To change the default name, select **IMPLEMENT NAME** and enter the new name, then confirm.

The New Implement Setup wizard displays.

5. Select **ECU TYPE**, select **ASC-10**, then confirm and select next.
6. Select **IMPLEMENT CONTROL** and select **Section Control Only**.
7. Select **IMPLEMENT FUNCTION** and select **Plot Planter**.
8. When the screen shows that the setup is complete, confirm.

18.5.2. Plot planter user interface



When a plot planter type implement is loaded, the plot planter mini-view is enabled.

Note: An active AB guideline is required to begin setting up the plot locations. The 'A' point of the AB line should be at or before the intended start point of the first plot. See [Using straight lines guidelines, page 190](#).



- **Plot setup:** Opens a wizard to create plot boundaries on the display. See [Plot setup, page 245](#).

Note: Plots can also be imported as a shapefile format generated from an external tool. See [Creating a boundary from a shapefile, page 171](#).

- **Timing control:** Opens a setup window to configure the trigger pulse timing parameters. See [Timing control, page 246](#).
- **Auto**  **A**: Enables / disables automatically triggering the pulses when crossing parcel boundaries. Can be disabled if you need to cross the field while the implement is connected, but don't want to generate pulses.
- **Manual** : Immediately trigger a manual pulse at the current location.

Plot setup

- **Number of rows:** The number of rows of plots that will be generated to run parallel to the reference line, including the reference line. So '1' will generate a single row.
- **Plots per row:** The number of plots per row.
- **Propagation direction:** Whether to generate the plot rows to the left or right of the reference guideline. The first row will always be on the reference line. 'Left' and 'right' are determined relative to the line, not the vehicle position / heading, with the direction from A to B point being 'forward'. So if you generate plots on a recorded line they will always be the same no matter the current orientation of the vehicle.
- **Staggered planting:** Planting will be staggered between rows. Trigger points on every second row are offset by half the plot length (plus half the width of the gap between the plots).
- **Access width:** Between each plot in a row there is a gap. Enter a value wide enough for the vehicle to drive through. Default value is 2m.
- **Plot length:** Enter the required length of the plots.

- **A point offset:** How far the first plot in the reference guideline column is shifted towards the B point, from the A point. Effectively moves all of the generated plots up and down the AB line to compensate if the A point is not recorded exactly at the intended start point of the first plot, if required.

Note: The width of the row is determined by the width of the implement. See **(Swath Width)** [Setting the implement geometry, page 115](#).

The width of the gap between rows is determined by the width of the implement overlap. See **(Overlap)** [Setting the implement geometry, page 115](#). The required gap width must be entered as a negative number.

Timing control

The screenshot shows a 'Setup Triggers' dialog box with a blue header. Below the header is a navigation bar with left and right arrows and a 'Channel 0' label. The main content area is titled 'TRIGGER LOCATION Start of Plot'. It includes a 'Channel Enabled' toggle switch that is turned on. Below this are three sliders: 'Distance Offset' set to 0.0 m, 'Timing Offset' set to 1.0 s, and 'Pulse Duration' set to 1.2 s. At the bottom are 'Cancel' and 'OK' buttons.

- **Channel number:** Two channels are available. This enables a trigger pulse to be configured at both the start and at the end of the plot, if required. Select the channel for which you are setting the trigger pulse.

- **Trigger location:** The trigger pulse can be generated at the start or the end of a plot. The 'start' and 'end' locations are assigned to the plot at the points where the guideline intersects them. **Note:** During operation, the upcoming trigger location is shown on the screen by a dark red bar intersecting the current guideline at the next available plot.
- **Channel enabled:** Enable/disable the selected channel.
- **Distance offset:** A distance of +/- 5 metres can be added to the trigger location. This can be used to adjust the plot sizes for imported plots, or may be useful when plots are not strictly rectangular, allowing the operator to choose the location which is considered the 'true' start of the plot.
- **Timing offset:** Used to compensate for system lag in the implement control system. Using speed prediction, the pulse can be triggered between 0 and 5 seconds before crossing the point indicated by the trigger location. If, for example, the implement takes xx seconds to actuate into the 'open' position, adding an offset of that same interval will ensure the trigger occurs at the correct point.
Note: If the timing offset value for the implement being used is provided in metres, rather than seconds, **Distance offset** can be used to compensate for the system lag instead.
- **Pulse duration:** How long the pulse will be held for after being triggered. This can be set to between 0.1 and 5.0 seconds. This is applicable for both automatically triggered pulses and pulses triggered by the 'Manual' button in the mini view.

Chapter 19 – Inventory Manager

The Inventory Manager allows the operator to search for and view details of information items on the console, and make changes to those items. Items can be deleted, renamed or copied to or from USB. Task data on a USB or TAP can also be browsed and imported onto the console.

1. Select Inventory Manager  .

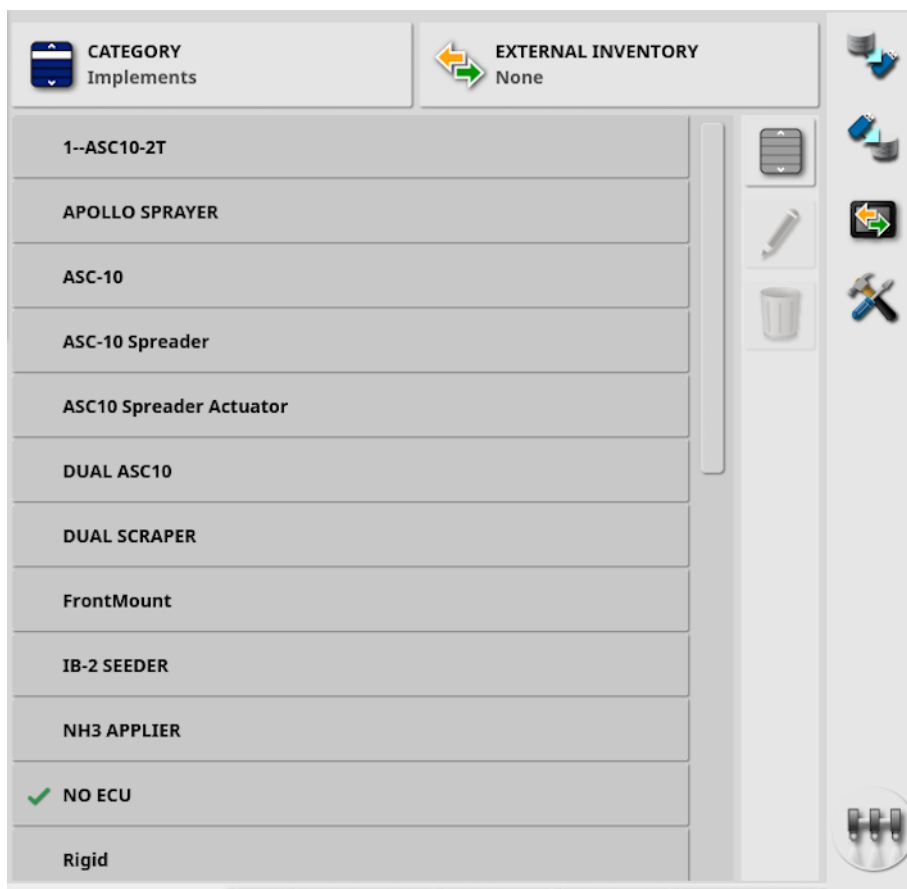

When opened, the screen shows a single list, which is the list of items corresponding to the selected **Category**. If a USB is inserted, or the display is connected to TAP, selecting an option from the **External Inventory** drop down list displays a split view.

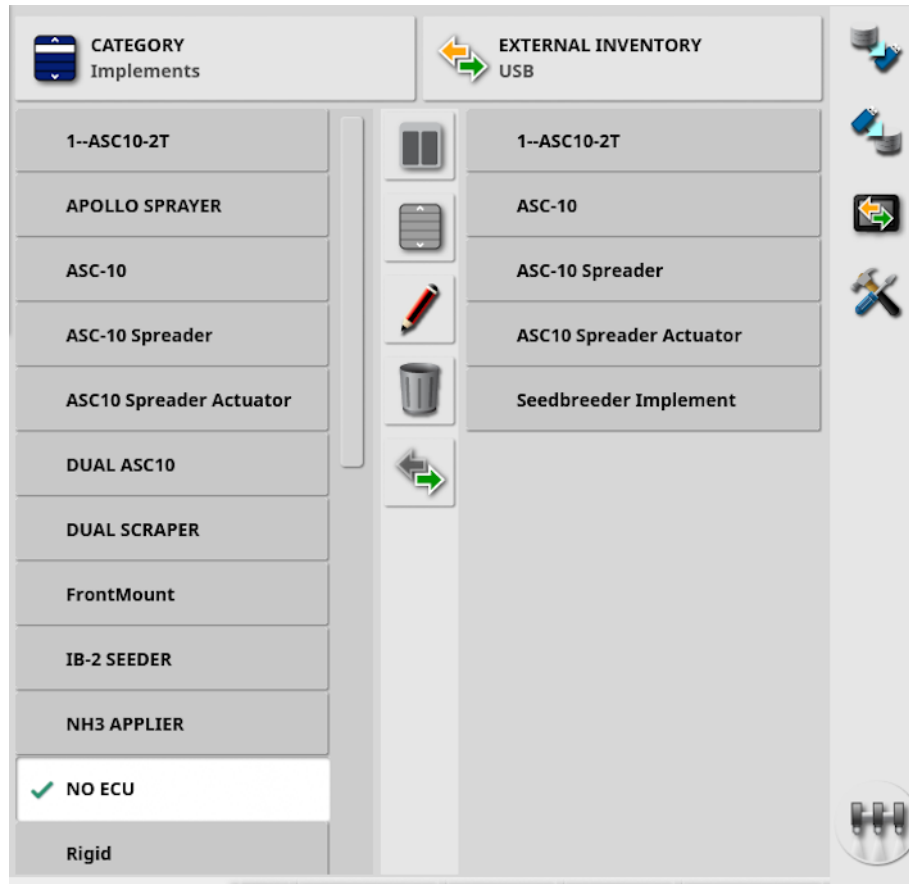

When the split view is displayed, the list on the left shows data stored on the display. The list on the right shows data stored on the external device selected in the **External Inventory** drop down list, which corresponds to the selected **Category**.

- **USB:** Display items on the USB, previously displayed by selecting . These items can be selected, renamed, deleted or copied to the console.
- **Select from USB:** Select a zip file (containing task data) or a TASKDATA.XML file directly, on the USB and import to the console. See [Importing a task data selection from a USB, page 257](#).
- **Select from TAP:** Select a zip file containing task data from TAP and import to the console. See [Importing a task data selection from TAP, page 258](#).

Note: If using an XD or X25 display and the split view is not displaying (the list on the right is not visible after a selection has been made from

the **External Inventory** drop down list), ensure that Inventory Manager is being displayed at full screen (no mini-views are open).

Note: Some items (such as Fields and Tasks) display additional filter

options when selected from the **Category** drop down list. Select  to display the filter options. The filters are applied to both lists if split view is in use.

Note: When filtering by implement , this displays a list of implements associated with the tasks on the system, not a list of the implement profiles on this console.



Hide / show split view.



Select all items from the list most recently selected.



Rename selected item.



Delete selected items.



Copy to or from display. Action is performed in the direction of the highlighted arrow.



Choose sort option to sort the lists (both lists will be sorted by the same criteria).



Back up all inventory items or user settings onto a USB. Existing data on the USB will be deleted.



Restore all inventory items or user settings. **Note:** This overwrites any data on the system and is used to restore content from a backup USB. Normally this is used by service personnel.



Exchange task data. Use to import from USB, export to USB and export to TAP. See [Importing a task data set from a USB, page 258](#) and [Exporting tasks / task data / task reports, page 252](#).



Save diagnostic information to the console. Use this when a dealer asks for it so the data can be assessed.

19.1. Exporting tasks / task data / task reports



Task: A task was previously referred to as a job in Horizon. It represents the work done at one time in a field.

Task data set: The task data set is a collection of tasks, as well as the data used to complete the task, such as field boundaries, guidelines and products.

19.1.1. Exporting tasks to a USB

Individual tasks can be exported to a USB to be transferred to another Topcon display or to be imported into a Farm Management Information System (FMIS).

The exported tasks are added to the task data set on the USB.

1. Insert the USB into the display.
2. Select Inventory Manager  .
3. Select **Tasks** from the **Category** drop down list.
4. Select **USB** from the **External Inventory** drop down list.
5. Select the task/s to be exported in the **Category** list on the left.
6. Select **Save selected items to USB**  .

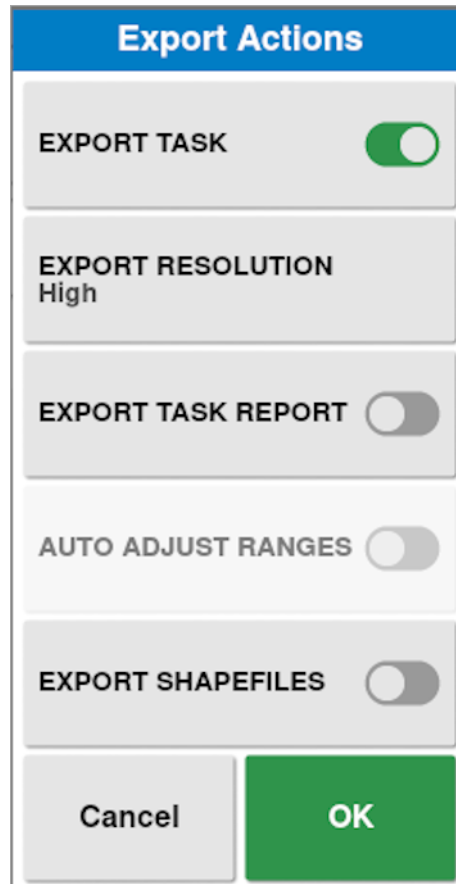

7. Select **Export task** and press **OK**.

Note: If required, **Export resolution** can be used to reduce the file size of data being exported from the display. This is achieved by transferring fewer data points, which will result in lower resolution coverage data.

Selecting **Export shapefiles** will generate coverage, guideline group and boundary shapefiles. These are saved in USB:\Reports under a date/time stamped folder. Note that pivots are not included in exported guideline shapefiles. If there are multiple guideline groups in the field, they are all exported in separate shapefiles. If guidelines groups is disabled, each guideline is exported in a separate shapefile.



Before removing the USB, always disconnect first by touching the **USB Eject** icon (see [Using the display toolbar, page 15](#)). A message will display that it is safe to remove the USB. If this is not done, the report may be missing or corrupt.

19.1.2. Exporting task reports to a USB

Exporting task reports to USB places the PDF reports in USB:\Reports.

1. Insert the USB into the display.

2. Select Inventory Manager  .

3. Select **Tasks** from the **Category** drop down list.

4. Select **USB** from the **External Inventory** drop down list.

5. Select the required task/s for PDF reports in the **Category** list on the left.

6. Select **Save selected items to USB**  .

7. Select **Export task report**.

8. Select **Auto adjust ranges** if required: If data exists that used a color legend, the colors used in the report map shading are altered so that the maximum variation in colors is used to illustrate yield rates.

Selecting **Export shapefiles** will generate coverage, guideline group and boundary shapefiles. These are saved in USB:\Reports under a date/time stamped folder.

19.1.3. Exporting a task data set to a USB

1. Insert the USB into the display.

2. Select Inventory Manager  .

3. Select **Exchange task data**  , then select **Export to USB**.



The following screen displays.

The screenshot shows a dialog box titled "Export Task Data" with a blue header. Below the header, it says "Step 1: Select Task Data export options". There are three grey rectangular boxes for configuration: "EXPORT VERSION" with "V4" below it, "EXPORT MODE" with "Keep all task data after export" below it, and "EXPORT RESOLUTION" with "High" below it. At the bottom, there are two buttons: a grey "Cancel" button and a yellow button with a white right-pointing arrow.

The task data set is exported as ISO XML. The export version may be changed to V3, if required.

4. Select the required export mode:
 - **Keep all task data after export:** All task data is retained on the display.
 - **Delete only tasks after export:** Tasks are deleted from the display but data such as clients, farms, fields, products and implements is retained.
 - **Delete all task data after export:** All task data is deleted from the display.



Note: If required, **Export resolution** can be used to reduce the file size of data being exported from the display. This is achieved by transferring fewer data points, which will result in lower resolution coverage data.

5. Select  and select the location on the USB to save the data.
6. Select  to confirm the export.

19.1.4. Exporting a task data set to TAP

Task data sets may be exported to TAP. The task data will include the client, farm, field (including boundaries, flag points, AB lines, curves and pivots) and task (including logged data).



Before using this option, enter a console name and login to TAP. See [Setting system settings, page 44](#).

1. Select Inventory Manager  .
 2. Select **Exchange task data**  / **Export to TAP**  .
 3. Select the required **Export mode**:
 - **Keep all task data after export**: All task data is retained on the display.
 - **Delete only tasks after export**: Tasks are deleted from the display but data such as clients, farms, fields, products and implements is retained.
 - **Delete all task data after export**: All task data is deleted from the display.
- Note:** If required, **Export resolution** can be used to reduce the file size of data being exported from the display. This is achieved by transferring fewer data points, which will result in lower resolution coverage data.
4. Confirm export.

19.2. Importing tasks and task data



Tasks can be imported onto another X display or into a Farm Management Information System (FMIS).

19.2.1. Importing tasks from a USB

1. Insert the USB into the display.
2. Select Inventory Manager .
3. Select **Tasks** from the **Category** drop down list.
4. Select **USB** from the **External Inventory** drop down list.
5. Highlight the task/s to be imported in the **External Inventory** list on the right, then select **Import selected items to console** .

19.2.2. Importing a task data selection from a USB

This option enables a selection of task data to be imported from a task data backup on a USB.

1. Insert the USB into the display.
2. Select Inventory Manager .
3. Select **Select from USB** from the **External Inventory** drop down list.
4. Navigate to the location on the USB containing the required task data and select **OK** to confirm.
The column on the right will display task data on the USB that corresponds with the **Category** selected on the left.
5. Highlight the data to be imported in the External Inventory list on the right, then select **Import selected items to console** .

19.2.3. Importing legacy Horizon 3 or 4 data from a USB

This option enables legacy Horizon 3 or 4 data (including products) to be converted to task data and stores the converted data on the USB in the

following file structure: ConvertedLegacyData / <today's_date>.

1. Insert the USB into the display.

2. Select Inventory Manager  .

3. Select **Convert legacy data** from the **External Inventory** drop down list.

Once the data conversion is complete, the column on the right will display task data on the USB that corresponds with the **Category** selected on the left.

4. Highlight the data to be imported in the External Inventory list on the right, then select **Import selected items to console**  .

19.2.4. Importing a task data set from a USB

CAUTION: Performing this operation will delete the existing task data set on the display, including all field boundaries, guidelines etc.

1. Insert the USB into the display.

2. Select Inventory Manager  .

3. Select **Exchange task data**  , then select **Import from USB**.

The toggle button  may be used to automatically search the top-level TASKDATA directory (if it exists), on the USB and list taskdata.xml files that are found. If this method is not successful, the USB may be browsed manually to select the required file.

4. Select the required task data set.

19.2.5. Importing a task data selection from TAP

This option enables a selection of task data to be imported from TAP.

Before using this option, enter a console name and login to TAP. See [Setting system settings, page 44](#).

1. Select Inventory Manager .
2. Select **Select from TAP** from the **External Inventory** drop down list.
3. Select the required .zip file and confirm. The zip file is automatically unzipped once it has been imported

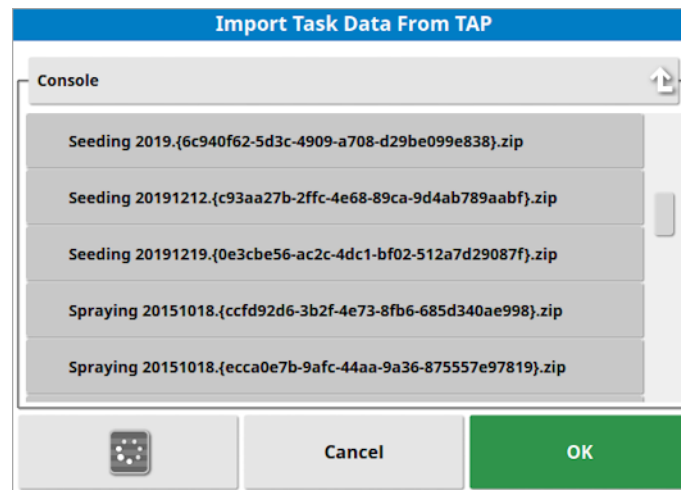

The refresh button  can be used to update the list of files displayed from TAP, if required.

4. Highlight the data to be imported in the External Inventory list on the right, then select **Import selected items to console** .

The column on the right will display task data from TAP that corresponds with the **Category** selected on the left.

Chapter 20 – Troubleshooting Guide

20.1. Common error messages

For many errors an error code, or Trouble Code, will display. It is also possible to view errors via the Steering Status screen (see [Auto steer status, page 219](#)), or the Diagnostics screen, Trouble Codes tab (see [Viewing diagnostics, page 138](#)).

The errors listed below are fairly common and may be corrected by the user. For other errors or if a problem persists, **always record the error message** to report to your dealer, including any code displayed.

Code	Fault	Action	Page
U1052	Steering subsystem firmware version is incorrect.	Upgrade the firmware.	59
U1054	Steering subsystem is in fault mode.	Please power cycle steering controller.	
U1055	Steering controller needs to be reset.	Please power cycle steering controller and the vehicle. Wait 20 seconds and restart.	
U1056	Steering controller configuration error.	Please repeat WAS calibration.	149
U1061	Tractor parameter settings not found in steering subsystem.	Return to main setup menu and confirm correct vehicle.	95
U1062	Mounting bias calibration required.	Calibrate mounting bias. This allows the system to compensate if the receiver is not level on the cab roof.	151

Code	Fault	Action	Page
U1065	Wheel angle sensor calibration required.	A change of tires is a common cause but is not the only possible cause. Confirm vehicle measurements and then recalibrate.	99 149
U1066	Compass calibration required.	Calibrate compass.	148
U1067	New vehicle or new steering controller has been detected.	Recalibrate compass.	148
U1068	Vehicle profile does not match steering subsystem settings.	Confirm steering subsystem is turned on. Return to main setup menu and reset vehicle and steering.	96 - 101
U1069	Steering subsystem steering wheel sensor is not configured.	Contact dealer.	
U1071	AES average power is greater than the power limit.	Confirm load on AES motor unit (for example the steering column is too heavy or the bushes or bearings are worn). Contact dealer.	
U1072	AES temperature greater than the temperature limit.	Turn off and allow to cool down. If problem persists contact the dealer.	

20.1. Common error messages

Code	Fault	Action	Page
U1074	AES steering controller not initialized.	Manually turn steering wheel by one quarter revolution.	
U1075- U1078	CAN receive or transmit errors.	Confirm connections. Power cycle the junction box. Contact dealer if the problem persists.	
U1079	Wheel angle sensor disconnected.	Check connection or replace faulty sensor. Contact dealer.	
U1080	Wheel angle sensor has short-circuited.	Contact dealer. Sensor may need to be replaced.	
U1082	Compact flash file system has less than 1% space remaining.	Confirm memory usage in the mini-view. It may be necessary to remove or transfer old files using inventory manager.	138 & 248
U3001	Transfer failed.	Try exporting or importing the file from USB again.	248
U4001	Wayline initialization error.	Recreate wayline.	190 - 195
U4006	Valid system calibrations do not exist.	Calibrate compass, wheel angle sensor and mounting bias.	148 - 151

Code	Fault	Action	Page
U5001	Steering subsystem not detected.	Confirm that steering subsystem is turned on. Confirm that 'road lock switch', which prevents engaging while on public roads, is off. Return to main setup menu to confirm correct steering system in setup.	101
U5002	Implement and wayline are not defined.	Confirm correct implement chosen and confirm correct field and task chosen. Create waylines if necessary.	110 161 & 178 190 - 216
U5003	Could not engage due to steering controller lockout.	Confirm road switch is OFF.	
U5004	Implement is not defined.	Confirm correct implement chosen.	110
U5007	Row spacing (implement overlap subtracted from implement width) is too small.	Overlap set is too large. Change overlap in auto section control mini-view. Refer to the controller's manual.	
U6904	Only one of the steering controller type and vehicle type is articulated.	Confirm settings in vehicle setup on the display match settings in the steering controller.	99 - 101

20.1. Common error messages

Code	Fault	Action	Page
U6905	Unknown machine type.	Return to main setup menu, and revise vehicle setup.	99
U8505	Factory calibration not present.	Calibrate compass, wheel angle sensor and mounting bias.	148 - 151
TC8	No 12V power supply to inertial sensor and modem.	Confirm connections.	

20.2. Internet connection issues

If you are experiencing problems when trying to connect the display to the internet (with an Ethernet cable plugged into the rear of the display), check the following:

1. Open the system information panel (see [Viewing system information, page 127](#)).
2. Under **Console**, check whether the **IP Address** is displaying an address in the range 192.168.0.x (where x = 0 - 255).
3. If this is the case, disconnect the Ethernet connection from the rear of the display and restart the display. This will drop the default address and allow the display to connect to the wireless hotspot.

The issue is a conflict between the default address used by the Ethernet connection when no Ethernet DHCP server is available (192.168.0.10) and the address acquired when setting up a wireless connection.

Chapter 21 – Glossary

Base Station	A GNSS receiver that supplies differential corrections to receivers equipped with GNSS. Also called a base or a reference station.
Baud Rate	This is the speed of data transfer, measured in bits per second.
Differential GPS	A method that uses correction data from satellite services or fixed reference stations to increase GPS accuracy. The satellites or local reference stations send correction data to vehicles equipped with GNSS receivers.
Easting/ Northing	<p>Eastings and Northings show the Universal Transverse Mercator (UTM) position and zone of the vehicle. They are measured in meters.</p> <p>The grid numbers on the east-west (horizontal) axis are called Eastings, and the grid numbers on the north-south (vertical) axis are called Northings.</p>
EGNOS	(European Geostationary Navigation Overlay Service) This is a European SBAS developed to supplement GPS, GLONASS and Galileo systems by reporting on the reliability and accuracy of the signals.
EMC	Electromagnetic Compatibility is the science that studies impact of electromagnetic interference. EMC aims to ensure that equipment items or systems will not interfere with each other or prevent correct operation through emissions.

Fallback	Satellites and correction sources require specific position accuracy when computing the position of the vehicle. If the system is not receiving enough data to compute the vehicle's position with the required accuracy, auto steering will not be enabled. The fallback feature allows the system to bypass the position accuracy requirement so that auto steering can be engaged. This is useful in situations where a high degree of position accuracy is not required.
Field	Defined working area of the tractor.
Field Boundary	The edge of the field.
Firmware	A computer program that is permanently embedded in the hardware of a device.
GDOP	(Geometric Dilution of Precision) GDOP is a metric used to quantify the accuracy of GNSS satellite geometry.
GLONASS	Global Navigation Satellite System (Russian GNSS)
GNSS	Global Navigation Satellite System
GPS	Global Positioning System (US GNSS)
Guideline	The virtual line between two way points in a field. The guideline is used as reference for further field runs (also Wayline).
HDOP	(Horizontal Dilution of Precision) HDOP is a metric for quantifying the accuracy of the horizontal (latitude/longitude) position information received from the GNSS satellites.
HRMS	The HRMS (Horizontal Root Mean Squared) calculates an average horizontal position from the source information from the satellites

Latitude	The distance of a position north or south of the equator measured in degrees. One minute latitude is equal to one nautical mile (1852 m). The equator has a latitude of zero.
Longitude	The distance of a position east or west from the prime meridian measured in degrees. The prime meridian runs through Greenwich, England and is zero longitude.
Mobile Base Station	A base station that can be easily moved and can independently determine its new position so that it can then continue working with the DGPS system.
Mounting Bias	Mounting bias refers to whether the receiver is exactly level, when installed.
MSAS	(Multi-functional Satellite Augmentation System) This is a Japanese SBAS which supplements the GPS by reporting and improving on the reliability and accuracy of the GPS signals.
NMEA	(National Marine Electronics Association) This is a standard protocol used by electronic devices to receive and transmit data.
OmniSTAR	A commercial service (operated by Trimble Navigation Ltd) that broadcasts GNSS correction data from a global constellation of geostationary satellites.
Reference Station	A GNSS receiver that supplies differential corrections to receivers equipped with GNSS. Also called a base station.

RTK Network	Association of base stations that transmit their position data to a server via the internet (NTRIP). The vehicles in the RTK network (rovers) also transmit their position to the server via mobile radio. The server uses the position data from the base stations and vehicles to calculate the correction data for each vehicle and transmits it to the vehicle via mobile radio. This allows position determination to be carried out with an accuracy of 1-2 cm in real time.
SBAS	(Satellite-Based Augmentation System) This is a system which supports wide area or regional augmentation through the use of additional satellite broadcast messages. SBAS correction sources are commonly composed of multiple ground stations which take the measurements of one or more GNSS satellites, and the satellite signals and environmental factors that may impact the signal.
Shapefile	A shapefile stores non-topological geometry and attribute information for the spatial features in a data set. The geometry for a feature is stored as a shape comprising a set of vector coordinates. It is in the form: abcd.shp
Task	A task was previously referred to as a job in Horizon. It represents the work done at one time in a field.
Task data set	The task data set is a collection of tasks, as well as the data used to complete the task, such as field boundaries, guidelines and products.
TopNET Global D	A commercial service (operated by TerraStar GNSS Ltd) that broadcasts GNSS correction data from a global constellation of geostationary satellites.

WAAS	(Wide Area Augmentation System) This US SBAS was developed by the US Federal Aviation Administration to serve as an air navigation aid by improving the accuracy and availability of the GPS signals.
WAS	Wheel angle sensor
Wayline	The virtual line between two way points in a field. The wayline is used as reference for further field runs (also Guideline).

Chapter 22 – Index

- AB lines 190
- access level 37
- alarms 70
- area counters 52
- auto section control 52, 234
- auto steer 50
 - disengaging 228
 - engaging 226
 - headlands 206
 - status 219
 - troubleshooting 220
 - tuning 224
- auto steering 219
- boom height 53, 241
- boundary
 - create 169
 - from shapefile 171
 - offset 169
 - remove 173
- boundary steering 51, 196
- calibration
 - compass 148
 - errors 156
 - mounting bias 151
 - steering 147
 - wheel angle sensor 149
- cameras 49
- CL-10 90
- CL-55 90
- client name 163
- colors 145
- compass calibration 148
- console
 - diagnostics 138
 - reset 12
 - shutting down 14
 - start 12
 - toolbar 15
- console name 44
- controlled traffic 50, 198
- coverage layer 131
- CropSpec 52
- dashboard 142
- date 27
- day / night 15
- diagnostics 138
- display name 44
- field
 - exit 164
 - new 163
 - select 162
 - unload 164
- field menu 161
- file names 146
- file server 48
- flag points
 - customize 165
 - edit 166
 - remove 166
 - set 165
 - setup 81
- GPS
 - accuracy 136
 - details 135
 - drift compensation 231
 - drift correction 167
 - output 67
 - radar 68
 - receiver 59
- groups
 - guidelines 214
- guidance screen 128
- guideline groups 50

- guidelines 187
 - AB lines 190
 - center pivot 194
 - copy 217
 - groups 214
 - guidelock 195
 - identical curve 193
 - import 217
 - select 189, 216
 - straight lines 190
- guidelock 51
- guidelock guidance mode 195
- headland 174
- headland turns 51, 206
- icon descriptions 6
- implement 21
 - create 112
 - geometry 115
 - master switch 121
 - select 110
 - setup 105
 - speed 104
- internet connection
 - troubleshooting 265
- inventory manager 248
- ISOBUS setup 82
- keep alive time 60
- language 27
- latitude 29
- LH5000 rate sensor 53
- licences 46
- lightbar 31
- longitude 29
- map layers 130
- map options 35
- map zoom 134
- master switch 121
- mini-views 125
- mounting bias calibration 151
- nitrogen 52
- NORAC 53, 241
- NTRIP 65
- nudge
 - offset 229
 - to vehicle 230
- nudge menu 229
- OAF file 60
- plot planter 243
- product database 123
- project lines 198
- regional settings 26
- remote support 40
- section control 117
 - section switch 120
 - timing 118
- serial ports 69
- software upgrade 22, 89
- steering calibration 147
- steering controller 101
- support 40
- system
 - diagnostics 138
- system information 127
- system setup 43
- TAP 3
- task
 - clear 182
 - complete 158
 - create 158, 179
 - export 252
 - import 257
 - pause 158
 - regions 180
 - select 178
- task boundary 168
- task button 158
- task data set
 - import 258

- task information 140
- task menu 178
- task report
 - batch export 254
 - export 254
- time 27
- timing
 - section control 118
- tramline control 51
- tramlines 51, 203
- troubleshooting 260
- units 28
- universal terminal 48, 237
- Universal terminal setup 82
- upgrade software 89
- USB Wi-Fi 90
- user access level 37
- user controls 38
- UT 237
- UT setup 82
- utilities 89
- variable rate control 53, 183
- VDC 57
- vehicle
 - antenna 103
 - create 96
 - geometry 99
 - orientation 136
 - select 95
 - setup 94
- Vehicle Display Controller 49, 57
- vehicle speed 104
- view controls 129
- volume 33
- VRC 183
- weather station 49, 239
- weigh scales 53
- What's new 1
- wheel angle sensor calibration 149
- Wi-Fi setup 90
- wireless 90
- XTEND 53

Chapter 23 – Regulatory and Safety Warnings

Terms and Conditions

Note: Please read these Terms and Conditions carefully.

General

APPLICATION - You accept these Terms and Conditions by purchasing the product from Topcon Precision Agriculture (TPA) or from one of TPA's product dealers.

COPYRIGHT - All information contained in this manual is the intellectual property of, and copyrighted material of TPA. All rights are reserved. You may not use, access, copy, store, display, create derivative works of, sell, modify, publish, distribute, or allow any third parties access to, any graphics, content, information or data in this manual without TPA's express written consent and may only use such information for the care and operation of your product. The information and data in this manual are a valuable asset of TPA and are developed by the expenditure of considerable work, time and money, and are the result of original selection, coordination and arrangement by TPA.

TRADEMARKS – ZYNX, PROSTEER, EAGLE, KEE Technologies, Topcon, Topcon Positioning Systems and Topcon Precision Agriculture are trademarks or registered trademarks of the Topcon Group of companies. Microsoft and Windows are trademarks or registered trademarks in the United States and/or other countries of Microsoft Corporation. Product and company names mentioned herein may be trademarks of their respective owners.

WEBSITE AND OTHER STATEMENTS - No statement contained at the website of TPA or any other Topcon Group company or in any other advertisements or TPA literature or made by an employee or independent contractor of TPA modifies these Terms and Conditions.

IMPORTANT: SAFETY - Improper use of the product can lead to death or injury to persons, damage to property and/or malfunction of the product. The product should only be repaired by authorized TPA service centers. You should closely review the safety warnings and directions as to the proper use of the product in this manual and at all times comply with the same.

Limited Warranty

ELECTRONIC AND MECHANICAL COMPONENTS - TPA warrants that the electronic components manufactured by TPA shall be free of defects in materials and workmanship for a period of one year from the original date of shipment to the dealer. TPA warrants that all valves, hoses, cables and mechanical parts manufactured by TPA shall be free of defects in materials and workmanship for a period of 90 days from the date of purchase.

RETURN AND REPAIR - During the respective warranty periods, any of the above items found defective may be shipped to TPA for repair. TPA will promptly repair or replace the defective item at no charge, and ship it back to you. You must pay the shipping and handling charges in respect of the same. Calibration of components, labor and travel expenses incurred for in-field removal and replacement of components are not covered in this warranty policy. The foregoing warranty shall NOT apply to damage or defects resulting from:

- (i) disaster, accident or abuse
- (ii) normal wear and tear
- (iii) improper use and/or maintenance
- (iv) unauthorized modifications of the product; and/or
- (v) use of the product in combination with other products not supplied or specified by TPA.

Software accompanying any product is licensed for use in connection with the product and not sold. Use of software that is provided with a separate end user license agreement (“EULA”) will be subject to the terms and conditions, including those relating to limited warranty, of the applicable EULA, notwithstanding anything in these Terms and Conditions to the contrary.

WARRANTY DISCLAIMER - OTHER THAN FOR THE ABOVE WARRANTIES, WARRANTIES PROVIDED IN AN APPLICABLE WARRANTY CARD, APPENDIX OR END USER LICENSE AGREEMENT, THIS MANUAL, THE PRODUCT AND RELATED SOFTWARE ARE PROVIDED ‘AS-IS’. THERE ARE NO OTHER WARRANTIES AND TO THE EXTENT ALLOWED BY LAW TPA EXCLUDES ALL IMPLIED TERMS, CONDITIONS AND WARRANTIES IN RESPECT OF THE MANUAL AND THE PRODUCT (INCLUDING ANY IMPLIED WARRANTY OR MERCHANTABILITY OR FITNESS FOR ANY PARTICULAR USE OR PURPOSE). TPA IS NOT RESPONSIBLE FOR THE OPERATION OF GNSS SATELLITES AND/OR AVAILABILITY, CONTINUITY, ACCURACY, OR INTEGRITY OF GNSS SATELLITE SIGNALS.

LIABILITY LIMIT AND INDEMNITY - TPA and its dealers, agents and representatives shall not be liable for technical or editorial errors or omissions contained herein or for special, indirect, economic, incidental or consequential damages resulting from the furnishing, performance or use of this material, the product or its accompanying software (including where TPA has been advised of the possibility of such damage). Such disclaimed damages include but are not limited to loss of time, loss or destruction of data, loss of profit, savings or revenue or loss of or damage to the product. You shall defend, indemnify and hold TPA harmless from and against any claims, actions, suits, damages, losses, liabilities and costs (including attorneys’ fees) arising from, or relating to (a) your operation use, or maintenance of the product and/or software other than as provided for in this manual or the applicable end user license agreement; and (b) your negligence or wrongful act or omission in respect of the product.

In any event, TPA’s liability to you or any other person for any claim, loss or damage (in contract, tort or on any other basis) will be limited (in TPA’s option) to either (a) the replacement or repair of the product, or (b) payment of the cost of replacing or repairing the product.

Other

These Terms and Conditions may be amended, modified, superseded or cancelled, at any time by TPA. These Terms and Conditions will be governed by, and construed in accordance with:

- the laws of South Australia if the product is sold and supplied to you in Australia (in which case the courts of South Australia or the Federal Court of Australia (Adelaide Registry) have exclusive jurisdiction in respect of any claim or dispute) or
- the laws of the State of California if the product is sold and supplied to you outside of Australia

- the provisions of the United Nations Convention on Contracts for the International Sale of Goods shall not apply to these Terms and Conditions.

All information, illustrations, and applications contained herein are based on the latest available information at the time of publication. TPA reserves the right to make product changes at any time without notice.

If any part of these Terms and Conditions would be unenforceable, the provision must be read down to the extent necessary to avoid that result, and if the provision cannot be read down to that extent, it must be severed without affecting the validity and enforceability of the remainder of these Terms and Conditions.

Service Information

Service assistance can be provided by contacting your local TPA Authorized Dealer.

Communications Regulation Information FCC Compliance Statement (USA)

FCC Title 47 §15.19(a)(3)

This device complies with part 15 of the FCC Rules. Operation is subject to the following two conditions: (1) This device may not cause harmful interference, and (2) this device must accept any interference received, including interference that may cause undesired operation.

FCC Title 47 §15.21

Changes or modifications made to this equipment not expressly approved by Topcon may void the FCC authorization to operate this equipment.

FCC Title 47 §15.105(a)

This equipment has been tested and found to comply with the limits for a Class A digital device, pursuant to part 15 of the FCC Rules. These limits are designed to provide reasonable protection against harmful interference when the equipment is operated in a commercial environment. This equipment generates, uses, and can radiate radio frequency energy and, if not installed and used in accordance with the instruction manual, may cause harmful interference to radio communications. Operation of this equipment in a residential area is likely to cause harmful interference in which case the user will be required to correct the interference at his own expense.

ISED Compliance Statement (Canada)

This Class A digital apparatus meets all requirements of the Canadian Interference-Causing Equipment Regulation.

CAN ICES-003(A)/NMB-003(A)

CE EMC Statement (European Community)

Warning: This is a class 'A' product. In a domestic environment this product may cause radio interference in which case the user may be required to take adequate measures.

XD2 complies with the essential requirements of EMC directive 2014/30/EU.

EMC Statement (Australia & New Zealand)

This product meets the applicable requirements of the Australia and New Zealand EMC Framework.

Radio and Television Interference

This computer equipment generates, uses, and can radiate radio-frequency energy. If it is not installed and used correctly in strict accordance with TOPCON Precision Agriculture instructions, it may cause interference with radio communication.

You can check if interference is being caused by this equipment by turning the Topcon equipment off to see if the interference stops. If the equipment is causing interference to a radio or other electronic device, try:

- Turning the radio antenna until the interference stops
- Moving the equipment to either side of the radio or other electronic device
- Moving the equipment farther away from the radio or other electronic device
- Connecting the equipment to another circuit that is not linked to the radio.

To reduce potential interference operate the equipment at the lowest gain level that will allow successful communication.

If necessary contact your nearest Topcon Precision Agriculture dealer for assistance.

Note: Changes or modifications to this product not authorized by TOPCON Precision Agriculture could void the EMC compliance and negate authority to operate the product.

This product was tested for EMC compliance using Topcon Precision Agriculture peripheral devices, shielded cables and connectors. It is important to use Topcon Precision Agriculture devices between system components to reduce the possibility of interference with other devices

General Safety



DANGER: It is essential that the following information and the product specific safety information is read and understood.

Most incidents arising during operation, maintenance and repair are caused by a failure to observe basic safety rules or precautions. Always be alert to potential hazards and hazardous situations.

Always follow the instructions that accompany a Warning or Caution. The information these provide aims to minimize risk of injury and/or damage to property.

In particular follow instructions presented as Safety Messages.

Safety Messages and Warnings

The safety symbol is used with the relevant word: DANGER, WARNING or CAUTION.

Messages marked in this way recommend safety precautions and practices. LEARN and apply them.



DANGER: Indicates an imminently hazardous situation that, if not avoided, could result in **DEATH OR VERY SERIOUS INJURY**.



WARNING: Indicates a potentially hazardous situation that, if not avoided, could result in **DEATH OR SERIOUS INJURY**.



CAUTION: Indicates a potentially hazardous situation that, if not avoided, may result in **MINOR INJURY**.

Safety Signs



WARNING: **DO NOT** remove or obscure safety signs. Replace any safety signs that are not readable or are missing. Replacement signs are available from your dealer in the event of loss or damage.

If a used vehicle has been purchased, make sure all safety signs are in the correct location and can be read. Replace any safety signs that cannot be read or are missing. Replacement safety signs are available from your dealer.

Operator Safety



WARNING: It is **YOUR** responsibility to read and understand the safety sections in this book before operating this vehicle. Remember that **YOU** are the key to safety.

Good safety practices not only protect you, but also the people around you. Study this manual as part of your safety program. This safety information only relates to Topcon equipment and does not replace other usual safe work practices.



WARNING: Ensure power is removed from the Topcon equipment prior to maintenance or repair of the vehicle or implements.



WARNING: Ensure appropriate precautions are taken prior to handling any hazardous substances. Always read the Material Safety Data Sheet prior to commencing work.



WARNING: In some of the illustrations or photos used in this manual, panels or guards may have been removed for demonstration purposes. Never operate the vehicle with any panels or guards removed. If the removal of panels or guards is necessary to make a repair, these **MUST** be replaced before operation.



WARNING: Always check that any suspended vehicle attachments are lowered to the ground before beginning repair or maintenance work on a vehicle.



WARNING: Vehicle and implement parts can become hot during operation and may be under pressure. Refer to vehicle manuals.



WARNING: Wear appropriate protective clothing for the task being undertaken and conditions.



WARNING: Do not operate equipment around explosive equipment or supplies.



WARNING: Topcon is committed to good environmental performance and minimizes the use of any potentially harmful substances in its products. However, it is always advisable not to handle damaged electronic equipment. This Topcon product may contain a sealed lithium battery. Always dispose of any electronic equipment thoughtfully and responsibly.

Preparation for Operation

- Read and understand this manual and learn all of the controls before you use the equipment.
- Keep the manual with the equipment.
- If the equipment is moved to another vehicle, move the manual as well.
- Read the manual for the vehicle with which the equipment will be used and check that the vehicle has the correct equipment required by local regulations.
- Make sure you understand the speed, brakes, steering, stability, and load characteristics of the vehicle before you start.
- Check all controls in an area clear of people and obstacles before starting work.
- Identify possible hazards.



WARNING: Topcon equipment must not be used by an operator affected by alcohol or drugs. Seek medical advice if using prescription or over-the-counter medication.

Disclaimer

Topcon accepts no responsibility or liability for damages to property, personal injuries, or death resulting from the misuse or abuse of any of its products.

Further, Topcon accepts no responsibility for the use of Topcon equipment or the GNSS signal for any purpose other than the intended purpose.

Topcon cannot guarantee the accuracy, integrity, continuity, or availability of the GNSS signal.

The operator must ensure that the equipment is correctly turned off when not in use.

Before operating any vehicle equipped with Topcon products, read and understand the following product specific safety precautions.

Important Safety Information

Operator Alertness and Responsibility

The display helps the operator to steer the vehicle, but the operator remains in charge and must be alert and in complete control of the vehicle at all times. The operator is ultimately responsible for safe operation of this equipment.

It is essential that safety requirements are met when operating the display and any of its components. All operators and other relevant personnel must be advised of safety requirements.

Electrical Safety



WARNING: Incorrectly connected power can cause severe injury and damage to people or the equipment.

When working with electrical components, you must do the following:

- Make sure the negative terminal of the battery is disconnected before doing any welding on the vehicle.
- Check that all power cables to system components are connected to the correct polarity as marked. Please refer to the vehicle manual for safety information.
- Check that equipment is grounded in accordance with installation instructions.

Operation and Risk of Obstacles

The following list is not exhaustive or limited. To use the display for assisted steering along a defined wayline, the operator must ensure that it is used:

- Away from people and obstacles
- Away from high voltage power lines or other overhead obstructions (identify any clearance problems before activating the display)
- On private property without public access
- Within cleared fields
- Off public roads or access ways.

Note that:

- The operator needs to know the vehicle's position and the field conditions at all times.
- The operator will need to respond if the GNSS satellite or differential correction signal is lost momentarily.
- The display cannot detect obstacles (people, livestock or other).
- Only use the display in areas that are clear of obstacles and keep a proper distance.
- Steering needs to be disengaged for manual control if an obstacle appears in the path or the vehicle moves away from the wayline.

On/Off and Manual Control



WARNING: Ensure the steering switch is Off to prevent unintentional engagement of the assisted steering. When repairing or maintaining the vehicle/implement, ensure the vehicle **CANNOT** be moved. Disengage steering, apply brakes and remove keys.

The operator must ensure that the steering switch is Off (*all* LED indicators are off) when assisted steering is not being used.

The operator must disengage assisted steering and use manual control if an obstacle is in the line of travel or moves into the line of travel, or if the vehicle steers away from the desired wayline.

To disengage assisted steering:

- Turn the steering wheel a few degrees OR
- Select the Disengage Auto Steering button on the display AND/OR
- If using an external steering switch, disengage using the switch if the above actions do not disengage assisted steering.

Vehicle Shut Down Safety

Before leaving the vehicle, disengage assisted steering, disengage external steering switch if this is being used, and remove the key from the key switch.

Transporting the Vehicle



WARNING: When transporting the vehicle on a public roadway, the auto-guidance system must be switched OFF. Ensure the steering switch is Off to prevent unintentional engagement of the assisted steering.

Using a Reference (Base) Station



WARNING: Do not move a reference station while in operation. Moving an operating reference station can interfere with the controlled steering of a system using the reference station. This could result in personal injury or damage to property.

Operators and other affected personnel must be advised of the following safety precautions.

- Do not erect the reference station under or within the vicinity of high voltage power lines.
- When using the portable reference station, make sure that the tripod is securely mounted.

To Get the Best Out of the Product

Back up data regularly. The display has large, but limited storage capacity. Use the Diagnostics Mini-view to view capacity available. A warning screen displays if storage is reaching its limit.

Be aware of file format compatibility. Discuss compatible formats with the dealer.

Topcon Agricultural Products are hardy and designed to work in tough conditions. However, if equipment is unused for a length of time, store away from water and direct heat sources.

Alert Symbols

In this manual two alert symbols are used:

Note: This offers additional information.



WARNING: A warning signal appears on safety signs and in this manual to show that this information is very important to your safety. **LEARN** these and **APPLY** them.

23.1. Topcon Positioning Systems, Inc. End User License Agreement

IMPORTANT: PLEASE READ CAREFULLY. The software product provided to you by Topcon Positioning Systems, Inc. ("**Topcon**") or its licensee along with its associated manuals and documentation (collectively, the "**Software**") is owned by Topcon and your use is subject to the terms and conditions of this End-User License Agreement ("**Agreement**"). The Software is intended for use on and/or as embedded in a Topcon display/console upon/in which the Software is intended (pursuant to its applicable documentation) to be installed and used (each a "**Device**"). If you are entering into this Agreement on behalf of a company or other legal entity, you represent that you have the authority to bind such entity to these terms and conditions, in which case the terms "**you**" or "**your**" shall refer to such entity. If you do not have such authority, or if you do not agree with these terms and conditions, you may not use the Software. Topcon also reserves the right to immediately terminate this Agreement for failure to comply with the terms provided herein. In the event of any conflict between a non-English language version of this Agreement and the English version, the English version shall prevail.

By clicking the "ACCEPT" button below, and/or by installing or using the Software on any Device in which the Software is embedded, you agree to be bound by the terms and conditions of this Agreement. If you do not agree, you will not be authorized to use the Software.



WARNING: The Device and software (the "**System**") may be used to assist with (a) steering ("**Steering Control**") and/or (b) planting, spraying, spreading or fertilizing ("**Applications**").

IMPORTANT: By accepting this Agreement and operating the System, you attest that you are properly trained in its use and that you have read and will follow the procedures and instructions within the applicable System Operator's Manuals. Improper operation may result in: (a) inaccurate Steering Control and/or Application performance; and (b) damage to property and equipment, serious injury to persons, poor yields and/or crop damage or failure. You are fully responsible for the control and use of the System and results thereof.

STEERING CONTROL:

- DO NOT use on public or private roads. While on a road Steering Control MUST be disabled.
- Steering Control will assist in steering to a pre-determined guideline; however, you must be alert and manually take control from time to time.
- While Steering Control is active you MUST:
 - manually turn the vehicle if the guideline will intersect with boundaries/obstacles.
 - take control if the vehicle or implement may contact boundaries or obstacles.
 - manually turn the vehicle on sharp corners.

23.1. Topcon Positioning Systems, Inc. End User License Agreement

- ensure the vehicle speed is suitable to safely follow the guideline.
- NEVER leave the vehicle steering station.

APPLICATIONS: You are responsible for: (a) accurately entering the information required for the System to apply Applications to your requirements and (b) calibrating the System and ensuring Applications are applied in accordance with specifications.

1. Professional Use. Topcon products, including the Software (“**Topcon Products**”), are designed to be used by professionals. Prior to use and operation, you should have received professional training in the operation and use of the Topcon Products and have good knowledge of agricultural practices and precision agriculture equipment. You must review and follow all user and safety instructions, including those set forth in the applicable System Operator’s Manuals, before operating, inspecting or adjusting any Topcon Products and/or related equipment.

2. License Grant/Restrictions.

2.1. Grant of License to Software. If you have purchased or otherwise received the Software from Topcon or as embedded in a Device, Topcon grants you a personal, non-exclusive, non-transferable (except as expressly set forth herein) license to use the Software under the terms stated herein and, in any case, only with a single Device running a validly licensed copy of the operating system for which the Software was designed (e.g., Linux, Android, iOS, Windows). You may permanently transfer rights under this Agreement only as part of a permanent sale or transfer of the Device (or equipment of which the Device is a component). The license is effective until terminated. Topcon may terminate your license if you fail to comply with the terms and conditions of this Agreement.

2.2. Restrictions on Use and Transfer. You may not modify, adapt, translate, reverse engineer, decompile, or disassemble the Software or create derivative works from the Software, any component thereof or any related documentation, nor may you remove, modify or hide or otherwise make unreadable or non-viewable any notice, legend, advice, watermark trademark, service mark, or other designation contained on the Software, component thereof, documentation, or output therefrom. You may not distribute copies of the Software to third parties, including, without limitation, rent, lease, or lend the Software to third parties. You agree to not use, permit the use, or use the Software in violation of any U.S. Federal, state, or local laws or regulations or any foreign law or regulation, including laws regarding intellectual property rights in or laws or regulations regarding the trading or exchange of securities or concerning the Software. You further agree to use the Software solely for its intended purpose.

2.3. Mandatory Updates. Topcon and/or its licensee may from time to time and at any time provide you and/or make available (whether electronically or otherwise) with updates to the Software. Your continued ability to use the Software may be subject to and conditioned on your permitting the installation of such updates or your prompt installation of them, as the case may be.

2.4. Pass-Through of Open Source Terms. Notwithstanding the foregoing license grant and restrictions, you acknowledge that certain components of the Software may be covered by so-called “open source” software licenses (“**Open Source Components**”), which means any software licenses approved as open source licenses by the Open Source Initiative or any substantially similar licenses, including without limitation any license that, as a condition of distribution of the software licensed under such license, requires that the distributor make the software available in source code format. Topcon shall provide a list of Open Source Components for a particular version of the Software within the software package. To the extent required by the licenses covering Open Source Components, the terms of such licenses will apply to such Open Source Components in lieu of the terms of this Agreement. To the extent the terms of the licenses applicable to Open Source Components prohibit any of the restrictions in this Agreement with respect to such Open Source Component, such restrictions will not apply to such Open Source Component. To the extent the terms of the licenses applicable to Open Source Components require Licensor to make an offer to provide source code or related information in connection with the Software, such offer is hereby made. Any request for source code or related information should be directed only to Topcon via email at OSinquiry@topcon.com.

3. Ownership. Title to and ownership of all proprietary rights in the Software, as well as any writings, works or copyrightable subject matter derived from the Software, will at all times be, and shall remain, the property of Topcon or any third party from whom Topcon has obtained rights. Except as expressly provided in this Agreement, no rights or licenses are granted to you by Topcon with regard to the Software.

4. Crash; Bug Reporting and Feedback. The Software provides you with the ability to report performance issues/feedback and suggestions to Topcon. In the event that you chose to report any performance issues to Topcon the Software will gather the relevant job file and Device and Software settings and save to a file that you may forward to Topcon. Such information and feedback shall be used by Topcon to develop, provide and improve Topcon’s products and services, resolve bugs and faults, and to facilitate the provision of Software updates, product development, management and support and other services to you (if any) related to the Software. You hereby grant to Topcon a perpetual license to use, perform, copy, modify of the information that you supply to Topcon under the process and for the purposes described in this Section 4.

5. Analytics; Use of Aggregate/Anonymized Data. The Software is enabled to share anonymized usage data with Topcon from time to time via the internet. Topcon uses such data in the aggregate, with anonymized usage data provided by other users, in the pursuit of its legitimate commercial interests, including for industry analysis, benchmarking, analytics, product/service improvement and development. **You agree that Topcon may collect, use and disclose such information that does not incorporate personal information or otherwise identify you or your users.** You may disable the analytics gathering functionality in the “Information” page in the Software.

5.1. Disclaimers. UNLESS OTHERWISE SET FORTH IN AN EXPRESS TOPCON WARRANTY SUPPLIED IN CONNECTION WITH THE SUPPLY OF THE DEVICE/SOFTWARE, THE SOFTWARE IS PROVIDED “AS IS” AND NEITHER TOPCON NOR ITS DISTRIBUTORS PROMISE, REPRESENTATION OR WARRANTIES, WHETHER EXPRESSED OR IMPLIED, REGARDING OR RELATING TO THE SOFTWARE AND TOPCON SPECIFICALLY DISCLAIMS IMPLIED WARRANTIES OF MERCHANTABILITY, NON-INFRINGEMENT AND FITNESS FOR A PARTICULAR PURPOSE WITH RESPECT TO SAID SOFTWARE OR THE USE THEREOF. TO THE MAXIMUM EXTENT ALLOWABLE BY LAW, THE UNIFORM COMMERCIAL CODE OR OTHER SIMILAR UNIFORM LAWS SHALL NOT APPLY TO THIS AGREEMENT.

YOU EXPRESSLY ACKNOWLEDGE AND AGREE THAT TO THE EXTENT PERMITTED BY APPLICABLE LAW, USE OF THE SOFTWARE AND ANY FEATURES/SERVICES PERFORMED BY OR ACCESSED THROUGH THE SOFTWARE IS AT YOUR SOLE RISK AND THAT THE ENTIRE RISK AS TO SATISFACTORY QUALITY, PERFORMANCE, ACCURACY AND ERROR IS WITH YOU.

TOPCON DOES NOT WARRANT THAT THE FUNCTIONS CONTAINED IN, OR SERVICES PERFORMED OR PROVIDED BY THE SOFTWARE WILL MEET YOUR REQUIREMENTS, THAT THE OPERATION OF THE SOFTWARE WILL BE UNINTERRUPTED OR ERROR-FREE OR OPERATE IN COMBINATION WITH ANY OTHER HARDWARE, SOFTWARE, SYSTEM OR DATA, THAT ANY SERVICES/FEATURES WILL CONTINUE TO BE AVAILABLE, THAT THE SOFTWARE OR SERVICES/FEATURES WILL BE CORRECTED, OR THAT THE SOFTWARE WILL BE COMPATIBLE OR WORK WITH ANY THIRD-PARTY SOFTWARE, HARDWARE/EQUIPMENT (e.g., consoles, connectivity hardware, ISOBus, ECUs, etc.), APPLICATIONS OR THIRD-PARTY SERVICES.

YOU AGREE THAT YOU ARE SOLELY RESPONSIBLE FOR THE PROPER MAINTENANCE, OPERATION AND SUPPORT OF THIRD-PARTY HARDWARE/EQUIPMENT THAT YOU MAY USE IN CONNECTION WITH THE SOFTWARE AND YOU ASSUME ALL RISK RELATED TO THE PROPER OPERATION, SUPPORT AND MAINTENANCE OF SUCH HARDWARE/EQUIPMENT.

TOPCON DOES NOT WARRANT OR GUARANTEE THE ACCURACY OR SERVICE OF GPS UNITS THAT ARE USED IN CONNECTION WITH THE SOFTWARE.

6. Limitation of Liability. TOPCON AND ITS DISTRIBUTORS SHALL NOT BE LIABLE FOR EDITORIAL ERRORS OR EDITORIAL OMISSIONS CONTAINED IN THE SOFTWARE OR ITS DOCUMENTATION. TO THE MAXIMUM EXTENT ALLOWABLE BY LAW, IN NO EVENT SHALL TOPCON, ITS PERSONNEL OR DISTRIBUTORS BE LIABLE UNDER ANY CLAIM, DEMAND OR ACTION ARISING OUT OF OR RELATING TO THE SOFTWARE, ITS USE, INSTALLATION OR TOPCON'S OR DISTRIBUTORS PERFORMANCE OR LACK THEREOF UNDER THIS AGREEMENT FOR ANY SPECIAL, INDIRECT, INCIDENTAL, EXEMPLARY OR CONSEQUENTIAL DAMAGES, WHETHER OR NOT TOPCON HAS BEEN ADVISED OF THE POSSIBILITY OF SUCH CLAIM,

DEMAND OR ACTION. UNDER NO CIRCUMSTANCES, INCLUDING BUT NOT LIMITED TO A NEGLIGENT ACT, WILL TOPCON OR ITS AFFILIATES, AGENTS, EMPLOYEES, OR DISTRIBUTORS OR LICENSORS BE LIABLE FOR ANY DAMAGES OF ANY KIND THAT RESULT FROM (i) THE USE OR THE INABILITY TO USE THE SOFTWARE; (ii) THE TIMELINESS, DELETION, MIS-DELIVERY, OR FAILURE TO STORE ANY DATA, COMMUNICATIONS OR SETTINGS; (iii) THE COST OF GETTING SUBSTITUTE GOODS AND SERVICES; OR (iv) UNAUTHORIZED ACCESS TO OR ALTERATION OF YOUR TRANSMISSIONS OR DATA EVEN IF SUCH PARTY HAS BEEN ADVISED OF THE POSSIBILITY OF SUCH DAMAGES. **In no event will Topcon's or its distributor's liability in connection under this Agreement exceed the amount you actually paid for the right to use the Software. This limitation is cumulative, with all payments to you for claims or damages being aggregated to determine satisfaction of the limit. The existence of one or more claims will not enlarge this limitation on amount.**

7. Indemnification. YOU SHALL INDEMNIFY AND HOLD TOPCON AND ITS AGENTS, OFFICERS, MANAGERS, EMPLOYEES AND DISTRIBUTORS HARMLESS FROM AND AGAINST ANY AND ALL CLAIMS, DEMANDS, SUITS, JUDGMENTS AND EXPENSES (INCLUDING REASONABLE LEGAL FEES AND EXPENSES) ARISING OUT OF OR RELATING TO THE BREACH BY YOU OF YOUR OBLIGATIONS UNDER THIS AGREEMENT. YOU AGREE TO GIVE TOPCON PROMPT NOTICE OF SUCH CLAIMS AND TO PERMIT TOPCON TO CONTROL THE DEFENSE OR SETTLEMENT THEREOF.

8. Export Control. You may not use or otherwise export or re-export the Software except as authorized by United States law and the laws of the jurisdiction(s) in which the Software was obtained. In particular, but without limitation, the Software may not be exported or re-exported (a) into any U.S. embargoed countries or (b) to anyone on the U.S. Treasury Department's list of Specially Designated Nationals or the U.S. Department of Commerce Denied Person's List or Entity List. By using the Software, you represent and warrant that you are not located in any such country or on any such list. You also agree that you will not use the Software for any purposes prohibited by United States law, including, without limitation, the development, design, manufacture or production of missiles, nuclear, chemical or biological weapons.

9. Data Protection. You and Topcon acknowledge and agree that you and Topcon will comply with any applicable data protection law. If it is necessary that Topcon will handle personal data, it will be processed by Topcon in accordance with the applicable data protection laws and Topcon's Privacy Statement available at: <https://www.topconpositioning.com>.

10. General. This Agreement shall be governed by and construed and enforced in accordance with the laws of the state of California, without regard to conflicts of laws provisions. Any action concerning this Agreement shall take place in the state or federal courts located in San Francisco, California. If for any reason any provision of this Agreement, or a portion thereof, shall be unenforceable, that provision shall be enforced

23.1. Topcon Positioning Systems, Inc. End User License Agreement

to the maximum extent permissible so as to affect the intent of this Agreement, and the remainder of this Agreement shall continue in full force and effect. This Agreement constitutes the entire agreement between us and you with respect to the Software and it supersedes all prior or contemporaneous communications, agreements and understandings between Topcon and you with respect to the subject matter hereof. No joint venture, partnership, employment, or agency relationship exists between you and Topcon as a result of this Agreement. The failure of Topcon to enforce any right or provision in this Agreement shall not constitute a waiver of such right or provision unless acknowledged and agreed to by Topcon in writing. A printed version of this Agreement shall be admissible in judicial or administrative proceedings.



Topcon Precision Agriculture

16900 West 118th Terrace
Olathe, KS 66061 USA
Phone: 866-486-7266

Topcon Positioning Systems, Inc.

7400 National Drive
Livermore CA 94551 USA
Phone: 925-245-8300
Fax: 925-245-8599

Topcon Precision Agriculture

14 Park Way
Mawson Lakes SA 5095 Australia
Phone: +61-8-8203-3300
Fax : +61-8-8203-3399

Topcon Precision Agriculture Europe

Avenida de la Industria 35
Tres Cantos 28760, Spain
Phone: +34-91-804-92-31
Fax: +34-91-803-14-15

Topcon Corporation

75-1 Hasunuma-cho, Itabashi-ku
Tokyo 174-8580 Japan
Phone: +81-3-5994-0671
Fax: +81-3-5994-0672

© 2022 Topcon Precision Agriculture All rights reserved
Specifications subject to change without notice



1046492-01